

Cominix



magafor

Vol.4





マシンリーマ

MF8650	超硬マシンリーマ	1
MF8600	超硬マシンリーマ	2
MF650	ハイスマシンリーマ	15
MF600	ハイスマシンリーマ	16

カウンターシンク

MF493A	90°防振3枚刃Red'Xコート	19
MF4731/MF4737 (MF4931/MF4937)	90°3枚刃Red'Xコート	20
MF431/MF437	90°3枚刃	21
MF8431-H	90°3枚刃Hard'Xコート	22
MF432	60°3枚刃	22
MF4721	90°1枚刃Red'Xコート	23
MF421	90°1枚刃	23
MF422	60°1枚刃	23
MF4811	90°ホールタイプTiNコート	24
MF411	90°ホールタイプ	24
MF412	60°ホールタイプ	24

NC スポットティングドリル

MF019(L/XL)	90°ダブルアングルポイントドリル	25
MF0919(L/XL)	90°ダブルアングルポイントドリルRed'Xコート	26
MF016(L/XL)	60°ダブルアングルポイントドリル	27
MF0916(L/XL)	60°ダブルアングルポイントドリルRed'Xコート	28
MF8119	90°ダブルアングルポイントドリル(超硬)	29
MF8119-H	90°ダブルアングルポイントドリル(超硬)Hard'Xコート	29
MF819-D	90°マイクロNCスポットティングドリル	29
MF819-DH	90°マイクロNCスポットティングドリルHard'Xコート	29
MF195	90°NCスポットティングドリル	30
MF0895	90°NCスポットティングドリル TiNコート	30
MF196	120°NCスポットティングドリル	30
MF0896	120°NCスポットティングドリル TiNコート	30
MF197	90°NCスポットティングドリル(ロング)	31
MF199	120°NCスポットティングドリル(ロング)	31
MF8195	90°NCスポットティングドリル(超硬)	31
MF8195-H	90°NCスポットティングドリル(超硬)Hard'Xコート	31
MF8196	120°NCスポットティングドリル(超硬)	31
MF8196-H	120°NCスポットティングドリル(超硬)Hard'Xコート	31
MF8197	90°NCスポットティングドリル(超硬ロング)	32
MF8197-H	90°NCスポットティングドリル(超硬ロング)Hard'Xコート	32
MF8190-H	142°NCスポットティングドリル(超硬)Hard'Xコート	32

センタードリル

MF110/118	60°ジャパンスタンダード	33
MF0818	60°ジャパンスタンダードTiNコート	33
MF15	90°タイプ	34
MF18	60°ロングタイプ	34
MF10	60°JIS I型	35
MF0811	60°JIS I型TiNコート	35
MF14	60°先端補強型	35
MF8100	60°JIS I型 超硬	36
MF13	タイプII	36

面取りカッタ

MF8480	両面取りカッタ 90°	37
MF8480-H	両面取りカッタ 90°Hard'Xコート	37
MF8490	両面取りカッタ 90°	38
MF8490-H	両面取りカッタ 90°Hard'Xコート	38
MF8460	両面取りカッタ 60°	39
MF8460-H	両面取りカッタ 60°Hard'Xコート	39
MF848-RH/MF849-RH	両面取りカッタ(ラジアス)	40
MF8550-H	R面取りエンドミル	41

多機能工具

MF007	コンビマグ多機能エンドミル90°	42
MF8090	マルチV多機能エンドミル90°	43
MF8090-H	マルチV多機能エンドミル90°Hard'Xコート	43
MF8089-LH	マルチV多機能エンドミル90°(ロング)	44
MF8088	マルチV多機能エンドミル60°	45
MF8088-H	マルチV多機能エンドミル60°Hard'Xコート	45
MF8092	マルチV多機能エンドミル120°	46
MF8092-H	マルチV多機能エンドミル120°Hard'Xコート	46
MF8540	彫刻用エンドミル 40°	47
MF8540-H	彫刻用エンドミル 40°Hard'Xコート	47
MF8560	彫刻用エンドミル 60°	47
MF8560-H	彫刻用エンドミル 60°Hard'Xコート	47
MF8590	彫刻用エンドミル 90°	47
MF8590-H	彫刻用エンドミル 90°Hard'Xコート	47

製品別推奨切削条件

カウンターシンク	48
センタードリル	49
NCスポットティングドリル	49
マシンリーマ	50
面取りカッタ	50
多機能工具	51



マガフォーは1937年の創立以来、センタードリルのエキスパートとして、世界40カ国以上の国と地域に供給し続けています。スイスの品質とフランスの技術を駆使し、高精度、高品質を誇りに、近年には全生産の65%以上のセンタードリルを輸出しています。これからも世界各国のユーザーの皆様のニーズにお応えします。

材質別ガイド

工具材質	工具硬度	ワーク材質
HSS ハイス	63HRc	軟鋼・一般鋼・ 非鉄金属・樹脂等加工
HSS Co コバルトハイス	65HRc	一般鋼・ 合金鋼 (<500N/mm ²)・ 鋳鉄加工
TiN コバルトハイス+ TiNコート	65HRc+ 2300HV	一般鋼・ 合金鋼 (500-1000N/mm ²)・ 鋳鉄加工
Red'X コバルトハイス+ Red'Xコート	65HRc+ 3500HV	一般鋼・合金鋼・ ステンレス加工
超硬 超硬合金	1800HV	一般鋼・合金鋼・ ステンレス・高硬度鋼 (HRc50以下)加工
Hard'X 超硬合金+ Hard'Xコート	1800HV+ 3500HV	一般鋼・合金鋼・ ステンレス・耐熱合金・ 高硬度鋼 (HRc50以上)加工

■ご案内

このたびは magafor 製品カタログをご覧いただき誠にありがとうございます。

本書には新製品を含め超硬製品・ハイス製品を掲載しておりますが、製品の品質、性能、および仕様などにつきましては、常に研究改良を加えておりますので、本書のそれと異なる場合もございます。あらかじめご了承ください。

本書は 2020 年 2 月現在のものであります。

■ご注意

製品をご使用になる前に、必ず、製品本体、箱、表示サイズ、取扱説明書の「警告表示」等をお読みください。

切削工具には鋭い切れ刃を有するものがあります。

お取り扱いの際には十分ご注意ください。

※WEB コード

黒字→標準在庫品 青字→メーカー取寄品



マシンリーマ

H7公差対応のスタンダード超硬リーマ！

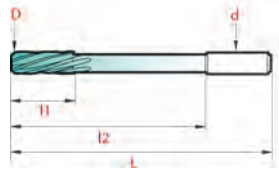

H7	超硬 K15	ネジレ角 左10°	食付角 45°
-----------	-------------------	----------------------	--------------------

公差				刃数	
D	d	l ₁	L	Z	φ
H7	h7	+1	±1	4	1.0~2.3
				6	2.4~13.0
				8	13.5~20.0

MF8650

型番	WEBコード	L	φ1	φ2	d	価格
MF8650 1.0	MA040	38	7	22	D	6,100
MF8650 1.1	MA078					5,900
MF8650 1.2	MA079					5,900
MF8650 1.3	MA080	40	10	24		5,900
MF8650 1.4	MA081					5,900
MF8650 1.5	MA041					5,800
MF8650 1.6	MA082	43	11	25		5,700
MF8650 1.7	MA083					5,700
MF8650 1.8	MA084					5,700
MF8650 1.9	MA085					5,700
MF8650 2.0	MA042	49	12	31		5,800
MF8650 2.1	MA086					5,700
MF8650 2.2	MA087					5,700
MF8650 2.3	MA088					5,700
MF8650 2.4	MA089					5,500
MF8650 2.5	MA043				5,800	
MF8650 2.6	MA090				5,500	
MF8650 2.7	MA091				5,500	
MF8650 2.8	MA092				5,500	
MF8650 2.9	MA093				5,500	
MF8650 3.0	MA044	57	18	38	5,800	
MF8650 3.1	MA094				5,500	
MF8650 3.2	MA095				5,500	
MF8650 3.3	MA096				5,500	
MF8650 3.4	MA097				5,500	
MF8650 3.5	MA045				5,800	
MF8650 3.6	MA098				5,500	
MF8650 3.7	MA099				5,500	
MF8650 3.8	MA100				6,050	
MF8650 3.9	MA101				6,050	
MF8650 4.0	MA046	75	19	51	4.0	5,900
MF8650 4.1	MA102				6,490	
MF8650 4.2	MA103				6,490	
MF8650 4.3	MA104				7,100	
MF8650 4.4	MA105				7,100	
MF8650 4.5	MA047	80	21	55	4.5	7,600
MF8650 4.6	MA106				7,100	
MF8650 4.7	MA107				7,100	
MF8650 4.8	MA108				6,720	
MF8650 4.9	MA109				6,720	
MF8650 5.0	MA048				6,300	
MF8650 5.1	MA110	86	23	60	5.0	7,150
MF8650 5.2	MA111				7,150	
MF8650 5.3	MA112				7,150	
MF8650 5.4	MA113				7,500	
MF8650 5.5	MA049				7,900	
MF8650 5.6	MA114	93	26	66	5.5	7,500
MF8650 5.7	MA115				7,500	
MF8650 5.8	MA116				7,500	
MF8650 5.9	MA117				7,170	
MF8650 6.0	MA050				7,100	
MF8650 6.1	MA118				7,170	
MF8650 6.2	MA119				7,170	
MF8650 6.3	MA120	101	28	73	6.0	7,170
MF8650 6.4	MA121				7,170	
MF8650 6.5	MA051				7,400	
MF8650 6.6	MA122				7,700	
MF8650 6.7	MA123				7,700	

MF8650

型番	WEBコード	L	φ1	φ2	d	価格	
MF8650 6.8	MA124				7.0	9,900	
MF8650 6.9	MA125					9,900	
MF8650 7.0	MA126					9,900	
MF8650 7.1	MA127	109	31	80		9,900	
MF8650 7.2	MA128					9,900	
MF8650 7.3	MA129					9,900	
MF8650 7.4	MA130					9,900	
MF8650 7.5	MA131					9,900	
MF8650 7.6	MA132					9,900	
MF8650 7.7	MA133					9,900	
MF8650 7.8	MA134					9,900	
MF8650 7.9	MA135					9,900	
MF8650 8.0	MA052	117	33	86		8.0	10,100
MF8650 8.1	MA136					9,900	
MF8650 8.2	MA137					9,900	
MF8650 8.3	MA138				9,900		
MF8650 8.4	MA139				9,900		
MF8650 8.5	MA140				9,900		
MF8650 8.6	MA141				13,420		
MF8650 8.7	MA142				13,420		
MF8650 8.8	MA143				13,420		
MF8650 8.9	MA144				13,420		
MF8650 9.0	MA145	125	36	91	9.0	13,420	
MF8650 9.1	MA146				13,420		
MF8650 9.2	MA147				13,420		
MF8650 9.3	MA148				13,420		
MF8650 9.4	MA149				13,420		
MF8650 9.5	MA150				13,420		
MF8650 9.6	MA151				13,420		
MF8650 9.7	MA152				13,420		
MF8650 9.8	MA153				13,420		
MF8650 9.9	MA154				13,420		
MF8650 10.0	MA053				13,440		
MF8650 10.1	MA155				16,800		
MF8650 10.2	MA156				16,800		
MF8650 10.3	MA157				16,800		
MF8650 10.4	MA158	133	38	99	10.0	16,800	
MF8650 10.5	MA159				15,800		
MF8650 10.6	MA160				17,380		
MF8650 10.7	MA161				17,380		
MF8650 10.8	MA162				17,380		
MF8650 10.9	MA163				17,380		
MF8650 11.0	MA164				16,800		
MF8650 11.1	MA165				17,380		
MF8650 11.2	MA166				17,380		
MF8650 11.3	MA167				17,380		
MF8650 11.4	MA168				17,380		
MF8650 11.5	MA169				17,380		
MF8650 11.6	MA170				17,380		
MF8650 11.7	MA171	151	44	106	12.0	17,380	
MF8650 11.8	MA172				17,380		
MF8650 11.9	MA173				17,380		
MF8650 12.0	MA054				17,470		
MF8650 14.0	MA055	160	47	110	14.0	29,120	
MF8650 15.0	MA056	162	50	112	14.0	32,470	
MF8650 16.0	MA057	170	52	117	16.0	33,590	
MF8650 18.0	MA058	182	56	129	16.0	40,310	
MF8650 20.0	MA059	195	60	142	16.0	51,510	

※φ1.0~φ12.0は超硬ソリッドタイプ。φ14.0~φ20.0はろう付タイプ。

マシンリーマ

マシンリーマ

各サイズ最大0~+0.005公差で各種穴仕上げ寸法に対応!

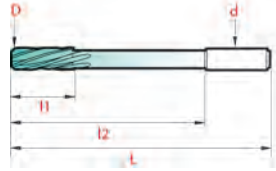

超硬 K15 **ネジレ角 左10°** **食付角 45°**

公差	D				刃数	
	D	d	l ₁	L	Z	φ
0.60~3.00	0,+0.003	h6	+1	±1	4	0.60~2.36
3.01~6.00	0,+0.004	h6	+1	±1	6	2.37~13.05
6.01~20.2	0,+0.005	h6	+1	±1	8	13.97~20.05

MF8600

型番	WEBコード	L	φ1	φ2	d	価格
MF8600 0.60	94220	33	7	17	D	8,880
MF8600 0.61	94221					8,880
MF8600 0.62	94222					8,880
MF8600 0.63	94223					8,880
MF8600 0.64	94224					8,880
MF8600 0.65	94225					8,880
MF8600 0.66	94226					8,880
MF8600 0.67	94227					8,880
MF8600 0.68	94228					8,880
MF8600 0.69	94229					8,880
MF8600 0.70	94230					6,630
MF8600 0.71	94231					6,630
MF8600 0.72	94232					6,630
MF8600 0.73	94233					6,630
MF8600 0.74	94234					6,630
MF8600 0.75	94235					6,630
MF8600 0.76	94236					6,630
MF8600 0.77	94237					6,630
MF8600 0.78	94238					6,630
MF8600 0.79	94239					6,630
MF8600 0.80	94240	6,230				
MF8600 0.81	94241	6,230				
MF8600 0.82	94242	6,230				
MF8600 0.83	94243	6,230				
MF8600 0.84	94244	6,230				
MF8600 0.85	94245	6,230				
MF8600 0.86	94246	6,230				
MF8600 0.87	94247	6,230				
MF8600 0.88	94248	6,230				
MF8600 0.89	94249	6,230				
MF8600 0.90	94250	6,230				
MF8600 0.91	94251	6,230				
MF8600 0.92	94252	6,230				
MF8600 0.93	94253	6,230				
MF8600 0.94	94254	6,230				
MF8600 0.95	94255	6,230				
MF8600 0.96	94256	6,230				
MF8600 0.97	94257	6,230				
MF8600 0.98	94258	6,230				
MF8600 0.99	94259	6,230				
MF8600 1.00	94260	6,230				
MF8600 1.01	94261	6,230				
MF8600 1.02	94262	6,230				
MF8600 1.03	94263	6,230				
MF8600 1.04	94264	6,230				
MF8600 1.05	94265	6,230				
MF8600 1.06	94266	6,020				
MF8600 1.07	94267	6,020				
MF8600 1.08	94268	6,020				
MF8600 1.09	94269	6,020				

MF8600

型番	WEBコード	L	φ1	φ2	d	価格
MF8600 1.10	94270	40	10	24	D	6,020
MF8600 1.11	94271					6,020
MF8600 1.12	94272					6,020
MF8600 1.13	94273					6,020
MF8600 1.14	94274					6,020
MF8600 1.15	94275					6,020
MF8600 1.16	94276					6,020
MF8600 1.17	94277					6,020
MF8600 1.18	94278					6,020
MF8600 1.19	94279					6,020
MF8600 1.20	94280					6,020
MF8600 1.21	94281					6,020
MF8600 1.22	94282					6,020
MF8600 1.23	94283					6,020
MF8600 1.24	94284					6,020
MF8600 1.25	94285					6,020
MF8600 1.26	94286					6,020
MF8600 1.27	94287					6,020
MF8600 1.28	94288					6,020
MF8600 1.29	94289					6,020
MF8600 1.30	94290	6,020				
MF8600 1.31	94291	6,020				
MF8600 1.32	94292	6,020				
MF8600 1.33	94293	6,020				
MF8600 1.34	94294	6,020				
MF8600 1.35	94295	6,020				
MF8600 1.36	94296	6,020				
MF8600 1.37	94297	6,020				
MF8600 1.38	94298	6,020				
MF8600 1.39	94299	6,020				
MF8600 1.40	94300	6,020				
MF8600 1.41	94301	6,020				
MF8600 1.42	94302	6,020				
MF8600 1.43	94303	6,020				
MF8600 1.44	94304	6,020				
MF8600 1.45	94305	6,020				
MF8600 1.46	94306	6,020				
MF8600 1.47	94307	6,020				
MF8600 1.48	94308	6,020				
MF8600 1.49	94309	6,020				
MF8600 1.50	94310	6,020				
MF8600 1.51	94311	6,020				
MF8600 1.52	94312	6,020				
MF8600 1.53	94313	6,020				
MF8600 1.54	94314	6,020				
MF8600 1.55	94315	6,020				
MF8600 1.56	94316	5,820				
MF8600 1.57	94317	5,820				
MF8600 1.58	94318	5,820				
MF8600 1.59	94319	5,820				

※ φ0.6~13.05 超硬ソリッドタイプ φ13.97~20.05 超硬ろう付タイプ

※ 在庫なくなり次第、取寄せ品となります。

マシンリーマ

各サイズ最大0~+0.005公差で各種穴仕上げ寸法に対応!

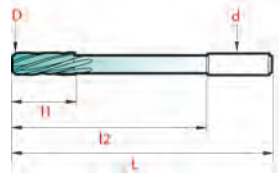

超硬 K15 ネジレ角 左10° 食付角 45°

公差	D				刃数	
	D	d	l ₁	L	Z	φ
0.60~3.00	0,+0.003	h6	+1	±1	4	0.60~2.36
3.01~6.00	0,+0.004	h6	+1	±1	6	2.37~13.05
6.01~20.2	0,+0.005	h6	+1	±1	8	13.97~20.05

MF8600

型番	WEBコード	L	φ1	φ2	d	価格
MF8600 1.60	94320	43	11	26	D	5,820
MF8600 1.61	94321					5,820
MF8600 1.62	94322					5,820
MF8600 1.63	94323					5,820
MF8600 1.64	94324					5,820
MF8600 1.65	94325					5,820
MF8600 1.66	94326					5,820
MF8600 1.67	94327					5,820
MF8600 1.68	94328					5,820
MF8600 1.69	94329					5,820
MF8600 1.70	94330					5,820
MF8600 1.71	94331					5,820
MF8600 1.72	94332					5,820
MF8600 1.73	94333					5,820
MF8600 1.74	94334					5,820
MF8600 1.75	94335					5,820
MF8600 1.76	94336					5,820
MF8600 1.77	94337					5,820
MF8600 1.78	94338	5,820				
MF8600 1.79	94339	5,820				
MF8600 1.80	94340	49	12	31	D	5,820
MF8600 1.81	94341					5,820
MF8600 1.82	94342					5,820
MF8600 1.83	94343					5,820
MF8600 1.84	94344					5,820
MF8600 1.85	94345					5,820
MF8600 1.86	94346					5,820
MF8600 1.87	94347					5,820
MF8600 1.88	94348					5,820
MF8600 1.89	94349					5,820
MF8600 1.90	94350					5,820
MF8600 1.91	94351					5,820
MF8600 1.92	94352					5,820
MF8600 1.93	94353					5,820
MF8600 1.94	94354					5,820
MF8600 1.95	94355					5,820
MF8600 1.96	94356					5,820
MF8600 1.97	94357					5,820
MF8600 1.98	94358	5,820				
MF8600 1.99	94359	5,820				
MF8600 2.00	94360	57	18	38	D	5,820
MF8600 2.01	94361					5,820
MF8600 2.02	94362					5,820
MF8600 2.03	94363					5,820
MF8600 2.04	94364					5,820
MF8600 2.05	94365					5,820
MF8600 2.06	94366					5,820
MF8600 2.07	94367					5,820
MF8600 2.08	94368					5,820
MF8600 2.09	94369					5,820

MF8600

型番	WEBコード	L	φ1	φ2	d	価格
MF8600 2.10	94370	49	12	31	D	5,820
MF8600 2.11	94371					5,820
MF8600 2.12	94372					5,820
MF8600 2.13	94373					5,820
MF8600 2.14	94374					5,820
MF8600 2.15	94375					5,820
MF8600 2.16	94376					5,820
MF8600 2.17	94377					5,820
MF8600 2.18	94378					5,820
MF8600 2.19	94379					5,820
MF8600 2.20	94380					5,820
MF8600 2.21	94381					5,820
MF8600 2.22	94382					5,820
MF8600 2.23	94383					5,820
MF8600 2.24	94384					5,820
MF8600 2.25	94385					5,820
MF8600 2.26	94386					5,820
MF8600 2.27	94387					5,820
MF8600 2.28	94388	5,820				
MF8600 2.29	94389	5,820				
MF8600 2.30	94390	57	18	38	D	5,820
MF8600 2.31	94391					5,620
MF8600 2.32	94392					5,620
MF8600 2.33	94393					5,620
MF8600 2.34	94394					5,620
MF8600 2.35	94395					5,620
MF8600 2.36	94396					5,620
MF8600 2.37	94397					5,620
MF8600 2.38	94398					5,620
MF8600 2.39	94399					5,620
MF8600 2.40	94400					5,620
MF8600 2.41	94401					5,620
MF8600 2.42	94402					5,620
MF8600 2.43	94403					5,620
MF8600 2.44	94404					5,620
MF8600 2.45	94405					5,620
MF8600 2.46	94406					5,620
MF8600 2.47	94407					5,620
MF8600 2.48	94408	5,620				
MF8600 2.49	94409	5,620				
MF8600 2.50	94410	5,620				
MF8600 2.51	94411	5,620				
MF8600 2.52	94412	5,620				
MF8600 2.53	94413	5,620				
MF8600 2.54	94414	5,620				
MF8600 2.55	94415	5,620				
MF8600 2.56	94416	5,620				
MF8600 2.57	94417	5,620				
MF8600 2.58	94418	5,620				
MF8600 2.59	94419	5,620				

※ φ0.6~13.05 超硬ソリッドタイプ φ13.97~20.05 超硬ろう付タイプ

※ 在庫なくなり次第、取寄せ品となります。

マシンリーマ

マシンリーマ

各サイズ最大0~+0.005公差で各種穴仕上げ寸法に対応!

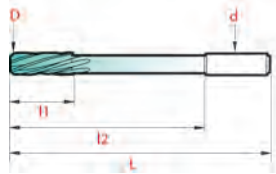

超硬 K15
ネジレ角 左10°
食付角 45°

公差	D				d		刃数	
	D	d	l ₁	L	Z	φ		
0.60~3.00	0,+0.003	h6	+1	±1	4	0.60~2.36		
3.01~6.00	0,+0.004	h6	+1	±1	6	2.37~13.05		
6.01~20.2	0,+0.005	h6	+1	±1	8	13.97~20.05		

MF8600

型番	WEBコード	L	φ1	φ2	d	価格
MF8600 2.60	94420					5,620
MF8600 2.61	94421					5,620
MF8600 2.62	94422					5,620
MF8600 2.63	94423					5,620
MF8600 2.64	94424					5,620
MF8600 2.65	94425					5,620
MF8600 2.66	94426					5,620
MF8600 2.67	94427					5,620
MF8600 2.68	94428					5,620
MF8600 2.69	94429					5,620
MF8600 2.70	94430					5,620
MF8600 2.71	94431					5,620
MF8600 2.72	94432					5,620
MF8600 2.73	94433					5,620
MF8600 2.74	94434					5,620
MF8600 2.75	94435					5,620
MF8600 2.76	94436					5,620
MF8600 2.77	94437					5,620
MF8600 2.78	94438					5,620
MF8600 2.79	94439					5,620
MF8600 2.80	94440					5,620
MF8600 2.81	94441					5,620
MF8600 2.82	94442					5,620
MF8600 2.83	94443					5,620
MF8600 2.84	94444					5,620
MF8600 2.85	94445	57	18	38	D	5,620
MF8600 2.86	94446					5,620
MF8600 2.87	94447					5,620
MF8600 2.88	94448					5,620
MF8600 2.89	94449					5,620
MF8600 2.90	94450					5,620
MF8600 2.91	94451					5,620
MF8600 2.92	94452					5,620
MF8600 2.93	94453					5,620
MF8600 2.94	94454					5,620
MF8600 2.95	94455					5,620
MF8600 2.96	94456					5,620
MF8600 2.97	94457					5,620
MF8600 2.98	94458					5,620
MF8600 2.99	94459					5,620
MF8600 3.00	94460					5,620
MF8600 3.01	94461					5,620
MF8600 3.02	94462					5,620
MF8600 3.03	94463					5,620
MF8600 3.04	94464					5,620
MF8600 3.05	94465					5,620
MF8600 3.06	94466					5,620
MF8600 3.07	94467					5,620
MF8600 3.08	94468					5,620
MF8600 3.09	94469					5,620

※ φ0.6~13.05 超硬ソリッドタイプ φ13.97~20.05 超硬ろう付タイプ

MF8600

型番	WEBコード	L	φ1	φ2	d	価格
MF8600 3.10	94470					5,620
MF8600 3.11	94471					5,620
MF8600 3.12	94472					5,620
MF8600 3.13	94473					5,620
MF8600 3.14	94474					5,620
MF8600 3.15	94475					5,620
MF8600 3.16	94476					5,620
MF8600 3.17	94477					5,620
MF8600 3.18	94478					5,620
MF8600 3.19	94479					5,620
MF8600 3.20	94480					5,620
MF8600 3.21	94481					5,620
MF8600 3.22	94482					5,620
MF8600 3.23	94483					5,620
MF8600 3.24	94484					5,620
MF8600 3.25	94485					5,620
MF8600 3.26	94486					5,620
MF8600 3.27	94487					5,620
MF8600 3.28	94488					5,620
MF8600 3.29	94489					5,620
MF8600 3.30	94490					5,620
MF8600 3.31	94491					5,620
MF8600 3.32	94492					5,620
MF8600 3.33	94493					5,620
MF8600 3.34	94494					5,620
MF8600 3.35	94495	57	18	38	D	5,620
MF8600 3.36	94496					5,620
MF8600 3.37	94497					5,620
MF8600 3.38	94498					5,620
MF8600 3.39	94499					5,620
MF8600 3.40	94500					5,620
MF8600 3.41	94501					5,620
MF8600 3.42	94502					5,620
MF8600 3.43	94503					5,620
MF8600 3.44	94504					5,620
MF8600 3.45	94505					5,620
MF8600 3.46	94506					5,620
MF8600 3.47	94507					5,620
MF8600 3.48	94508					5,620
MF8600 3.49	94509					5,620
MF8600 3.50	94510					5,620
MF8600 3.51	94511					5,620
MF8600 3.52	94512					5,620
MF8600 3.53	94513					5,620
MF8600 3.54	94514					5,620
MF8600 3.55	94515					5,620
MF8600 3.56	94516					5,620
MF8600 3.57	94517					5,620
MF8600 3.58	94518					5,620
MF8600 3.59	94519					5,620

※ 在庫なくなり次第、取寄せ品となります。

マシンリーマ

各サイズ最大0~+0.005公差で各種穴仕上げ寸法に対応!

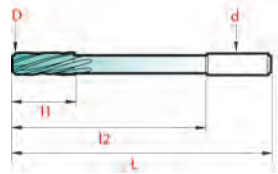

超硬 K15
ネジレ角 左10°
食付角 45°

公差	刃数			
	D	d	l ₁	L
0.60~3.00	0,+0.003	h6	+1	±1
3.01~6.00	0,+0.004	h6	+1	±1
6.01~20.2	0,+0.005	h6	+1	±1

Z	φ
6	2.37~13.05
8	13.97~20.05

MF8600

型番	WEBコード	L	φ1	φ2	d	価格
MF8600 3.60	94520	57	18	38	D	5,620
MF8600 3.61	94521					5,620
MF8600 3.62	94522					5,620
MF8600 3.63	94523					5,620
MF8600 3.64	94524					5,620
MF8600 3.65	94525					5,620
MF8600 3.66	94526					5,620
MF8600 3.67	94527					5,620
MF8600 3.68	94528					5,620
MF8600 3.69	94529					5,620
MF8600 3.70	94530					5,620
MF8600 3.71	94531					5,620
MF8600 3.72	94532					5,620
MF8600 3.73	94533					5,620
MF8600 3.74	94534					5,620
MF8600 3.75	94535					5,620
MF8600 3.76	94536					5,900
MF8600 3.77	94537					5,900
MF8600 3.78	94538	5,900				
MF8600 3.79	94539	5,900				
MF8600 3.80	94540	5,900				
MF8600 3.81	94541	5,900				
MF8600 3.82	94542	5,900				
MF8600 3.83	94543	5,900				
MF8600 3.84	94544	5,900				
MF8600 3.85	94545	5,900				
MF8600 3.86	94546	5,900				
MF8600 3.87	94547	5,900				
MF8600 3.88	94548	5,900				
MF8600 3.89	94549	5,900				
MF8600 3.90	94550	5,900				
MF8600 3.91	94551	75	19	51	4.0	5,900
MF8600 3.92	94552					5,900
MF8600 3.93	94553					5,900
MF8600 3.94	94554					5,900
MF8600 3.95	94555					5,900
MF8600 3.96	94556					5,900
MF8600 3.97	94557					5,900
MF8600 3.98	94558					5,900
MF8600 3.99	94559					5,900
MF8600 4.00	94560					5,900
MF8600 4.01	94561					5,900
MF8600 4.02	94562					5,900
MF8600 4.03	94563					5,900
MF8600 4.04	94564					5,900
MF8600 4.05	94565					5,900
MF8600 4.06	94566					5,900
MF8600 4.07	94567					5,900
MF8600 4.08	94568					5,900
MF8600 4.09	94569	5,900				

MF8600

型番	WEBコード	L	φ1	φ2	d	価格
MF8600 4.10	94570	75	19	51	4.0	5,900
MF8600 4.11	94571					5,900
MF8600 4.12	94572					5,900
MF8600 4.13	94573					5,900
MF8600 4.14	94574					5,900
MF8600 4.15	94575					5,900
MF8600 4.16	94576					5,900
MF8600 4.17	94577					5,900
MF8600 4.18	94578					5,900
MF8600 4.19	94579					5,900
MF8600 4.20	94580					6,270
MF8600 4.21	94581					6,270
MF8600 4.22	94582					6,270
MF8600 4.23	94583					6,270
MF8600 4.24	94584					6,270
MF8600 4.25	94585					6,270
MF8600 4.26	94586					7,100
MF8600 4.27	94587					7,100
MF8600 4.28	94588	7,100				
MF8600 4.29	94589	7,100				
MF8600 4.30	94590	7,100				
MF8600 4.31	94591	7,100				
MF8600 4.32	94592	7,100				
MF8600 4.33	94593	7,100				
MF8600 4.34	94594	7,100				
MF8600 4.35	94595	7,100				
MF8600 4.36	94596	7,100				
MF8600 4.37	94597	7,100				
MF8600 4.38	94598	7,100				
MF8600 4.39	94599	7,100				
MF8600 4.40	94600	7,100				
MF8600 4.41	94601	80	21	55	4.5	7,100
MF8600 4.42	94602					7,100
MF8600 4.43	94603					7,100
MF8600 4.44	94604					7,100
MF8600 4.45	94605					7,100
MF8600 4.46	94606					7,100
MF8600 4.47	94607					7,100
MF8600 4.48	94608					7,100
MF8600 4.49	94609					7,100
MF8600 4.50	94610					7,100
MF8600 4.51	94611					7,100
MF8600 4.52	94612					7,100
MF8600 4.53	94613					7,100
MF8600 4.54	94614					7,100
MF8600 4.55	94615					7,100
MF8600 4.56	94616					7,100
MF8600 4.57	94617					7,100
MF8600 4.58	94618					7,100
MF8600 4.59	94619	7,100				

※ φ0.6 ~ 13.05 超硬ソリッドタイプ φ13.97 ~ 20.05 超硬ろう付タイプ

※ 在庫なくなり次第、取寄せ品となります。

マシンリーマ

マシンリーマ

各サイズ最大0~+0.005公差で各種穴仕上げ寸法に対応!

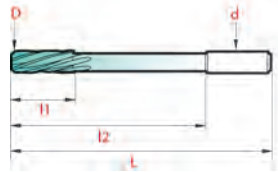

超硬 K15
ネジレ角 左10°
食付角 45°

公差	D				d		刃数	
	D	d	l ₁	L	Z	φ		
0.60~3.00	0,+0.003	h6	+1	±1	4	0.60~2.36		
3.01~6.00	0,+0.004	h6	+1	±1	6	2.37~13.05		
6.01~20.2	0,+0.005	h6	+1	±1	8	13.97~20.05		

MF8600

型番	WEBコード	L	φ1	φ2	d	価格
MF8600 4.60	94620	80	21	55	4.5	7,100
MF8600 4.61	94621					7,100
MF8600 4.62	94622					7,100
MF8600 4.63	94623					7,100
MF8600 4.64	94624					7,100
MF8600 4.65	94625					7,100
MF8600 4.66	94626					7,100
MF8600 4.67	94627					7,100
MF8600 4.68	94628					7,100
MF8600 4.69	94629					7,100
MF8600 4.70	94630					7,100
MF8600 4.71	94631					7,100
MF8600 4.72	94632					7,100
MF8600 4.73	94633					7,100
MF8600 4.74	94634					7,100
MF8600 4.75	94635					7,100
MF8600 4.76	94636					6,500
MF8600 4.77	94637					6,500
MF8600 4.78	94638	6,500				
MF8600 4.79	94639	6,500				
MF8600 4.80	94640	6,500				
MF8600 4.81	94641	6,500				
MF8600 4.82	94642	6,500				
MF8600 4.83	94643	6,500				
MF8600 4.84	94644	6,500				
MF8600 4.85	94645	6,500				
MF8600 4.86	94646	6,500				
MF8600 4.87	94647	6,500				
MF8600 4.88	94648	6,500				
MF8600 4.89	94649	6,500				
MF8600 4.90	94650	6,500				
MF8600 4.91	94651	86	23	60	5.0	6,500
MF8600 4.92	94652					6,500
MF8600 4.93	94653					6,500
MF8600 4.94	94654					6,500
MF8600 4.95	94655					6,500
MF8600 4.96	94656					6,500
MF8600 4.97	94657					6,500
MF8600 4.98	94658					6,500
MF8600 4.99	94659					6,500
MF8600 5.00	94660					6,500
MF8600 5.01	94661					6,500
MF8600 5.02	94662					6,500
MF8600 5.03	94663					6,500
MF8600 5.04	94664					6,500
MF8600 5.05	94665					6,500
MF8600 5.06	94666					6,500
MF8600 5.07	94667					6,500
MF8600 5.08	94668					6,500
MF8600 5.09	94669	6,500				

MF8600

型番	WEBコード	L	φ1	φ2	d	価格
MF8600 5.10	94670	86	23	60	5.0	6,500
MF8600 5.11	94671					6,500
MF8600 5.12	94672					6,500
MF8600 5.13	94673					6,500
MF8600 5.14	94674					6,500
MF8600 5.15	94675					6,500
MF8600 5.16	94676					6,500
MF8600 5.17	94677					6,500
MF8600 5.18	94678					6,500
MF8600 5.19	94679					6,500
MF8600 5.20	94680					6,500
MF8600 5.21	94681					6,500
MF8600 5.22	94682					6,500
MF8600 5.23	94683					6,500
MF8600 5.24	94684					6,500
MF8600 5.25	94685					6,500
MF8600 5.26	94686					6,500
MF8600 5.27	94687					6,500
MF8600 5.28	94688	6,500				
MF8600 5.29	94689	6,500				
MF8600 5.30	94690	6,500				
MF8600 5.31	94691	7,500				
MF8600 5.32	94692	7,500				
MF8600 5.33	94693	7,500				
MF8600 5.34	94694	7,500				
MF8600 5.35	94695	7,500				
MF8600 5.36	94696	7,500				
MF8600 5.37	94697	7,500				
MF8600 5.38	94698	7,500				
MF8600 5.39	94699	7,500				
MF8600 5.40	94700	7,500				
MF8600 5.41	94701	93	26	66	5.5	7,500
MF8600 5.42	94702					7,500
MF8600 5.43	94703					7,500
MF8600 5.44	94704					7,500
MF8600 5.45	94705					7,500
MF8600 5.46	94706					7,500
MF8600 5.47	94707					7,500
MF8600 5.48	94708					7,500
MF8600 5.49	94709					7,500
MF8600 5.50	94710					7,500
MF8600 5.51	94711					7,500
MF8600 5.52	94712					7,500
MF8600 5.53	94713					7,500
MF8600 5.54	94714					7,500
MF8600 5.55	94715					7,500
MF8600 5.56	94716					7,500
MF8600 5.57	94717					7,500
MF8600 5.58	94718					7,500
MF8600 5.59	94719	7,500				

※ φ0.6~13.05 超硬ソリッドタイプ φ13.97~20.05 超硬ろう付タイプ

※ 在庫なくなり次第、取寄せ品となります。

マシンリーマ

各サイズ最大0~+0.005公差で各種穴仕上げ寸法に対応!

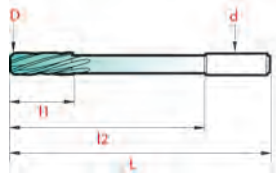

超硬 K15
ネジレ角 左10°
食付角 45°

公差	D				d		刃数	
	D	d	l ₁	L	Z	φ		
0.60~3.00	0,+0.003	h6	+1	±1	4	0.60~2.36		
3.01~6.00	0,+0.004	h6	+1	±1	6	2.37~13.05		
6.01~20.2	0,+0.005	h6	+1	±1	8	13.97~20.05		

MF8600

型番	WEBコード	L	φ1	φ2	d	価格
MF8600 5.60	94720					7,500
MF8600 5.61	94721					7,500
MF8600 5.62	94722					7,500
MF8600 5.63	94723					7,500
MF8600 5.64	94724					7,500
MF8600 5.65	94725					7,500
MF8600 5.66	94726					7,500
MF8600 5.67	94727					7,500
MF8600 5.68	94728					7,500
MF8600 5.69	94729					7,500
MF8600 5.70	94730	93	26	66	5.5	7,500
MF8600 5.71	94731					7,500
MF8600 5.72	94732					7,500
MF8600 5.73	94733					7,500
MF8600 5.74	94734					7,500
MF8600 5.75	94735					7,500
MF8600 5.76	94736					7,500
MF8600 5.77	94737					7,500
MF8600 5.78	94738					7,500
MF8600 5.79	94739					7,500
MF8600 5.80	94740					7,500
MF8600 5.81	94741					7,000
MF8600 5.82	94742					7,000
MF8600 5.83	94743					7,000
MF8600 5.84	94744					7,000
MF8600 5.85	94745					7,000
MF8600 5.86	94746					7,000
MF8600 5.87	94747					7,000
MF8600 5.88	94748					7,000
MF8600 5.89	94749					7,000
MF8600 5.90	94750					7,000
MF8600 5.91	94751					7,000
MF8600 5.92	94752					7,000
MF8600 5.93	94753					7,000
MF8600 5.94	94754					7,000
MF8600 5.95	94755	101	28	73	6.0	7,000
MF8600 5.96	94756					7,000
MF8600 5.97	94757					7,000
MF8600 5.98	94758					7,000
MF8600 5.99	94759					7,000
MF8600 6.00	94760					7,000
MF8600 6.01	94761					7,000
MF8600 6.02	94762					7,000
MF8600 6.03	94763					7,000
MF8600 6.04	94764					7,000
MF8600 6.05	94765					7,000
MF8600 6.06	94766					7,000
MF8600 6.07	94767					7,000
MF8600 6.08	94768					7,000
MF8600 6.09	94769					7,000

MF8600

型番	WEBコード	L	φ1	φ2	d	価格
MF8600 6.10	94770					7,000
MF8600 6.11	94771					7,000
MF8600 6.12	94772					7,000
MF8600 6.13	94773					7,000
MF8600 6.14	94774					7,000
MF8600 6.15	94775					7,000
MF8600 6.16	94776					7,000
MF8600 6.17	94777					7,000
MF8600 6.18	94778					7,000
MF8600 6.19	94779					7,000
MF8600 6.20	94780					7,000
MF8600 6.21	94781					7,000
MF8600 6.22	94782					7,000
MF8600 6.23	94783					7,000
MF8600 6.24	94784					7,000
MF8600 6.25	94785					7,000
MF8600 6.26	94786					7,000
MF8600 6.27	94787					7,000
MF8600 6.28	94788					7,000
MF8600 6.29	94789					7,000
MF8600 6.30	94790					7,000
MF8600 6.31	94791					7,000
MF8600 6.32	94792					7,000
MF8600 6.33	94793					7,000
MF8600 6.34	94794	101	28	73	6.0	7,000
MF8600 6.35	94795					7,000
MF8600 6.36	94796					7,000
MF8600 6.37	94797					7,000
MF8600 6.38	94798					7,000
MF8600 6.39	94799					7,000
MF8600 6.40	94800					7,000
MF8600 6.41	94801					7,000
MF8600 6.42	94802					7,000
MF8600 6.43	94803					7,000
MF8600 6.44	94804					7,000
MF8600 6.45	94805					7,000
MF8600 6.46	94806					7,000
MF8600 6.47	94807					7,000
MF8600 6.48	94808					7,000
MF8600 6.49	94809					7,000
MF8600 6.50	94810					7,000
MF8600 6.51	94811					7,000
MF8600 6.52	94812					7,000
MF8600 6.53	94813					7,000
MF8600 6.54	94814					7,000
MF8600 6.55	94815					7,000
MF8600 6.56	94816					7,000
MF8600 6.57	94817					7,000
MF8600 6.58	94818					7,000
MF8600 6.59	94819					7,000

※ φ0.6~13.05 超硬ソリッドタイプ φ13.97~20.05 超硬ろう付タイプ

※ 在庫なくなり次第、取寄せ品となります。

マシンリーマ

マシンリーマ

各サイズ最大0~+0.005公差で各種穴仕上げ寸法に対応!

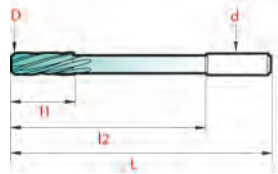

超硬 K15
ネジレ角 左10°
食付角 45°

公差	D				d		刃数	
	D	d	l ₁	L	Z	φ		
0.60~3.00	0,+0.003	h6	+1	±1	4	0.60~2.36		
3.01~6.00	0,+0.004	h6	+1	±1	6	2.37~13.05		
6.01~20.2	0,+0.005	h6	+1	±1	8	13.97~20.05		

MF8600

型番	WEBコード	L	φ1	φ2	d	価格
MF8600 6.60	94820	101	28	73	6.0	7,000
MF8600 6.61	94821					7,000
MF8600 6.62	94822					7,000
MF8600 6.63	94823					7,000
MF8600 6.64	94824					7,000
MF8600 6.65	94825					7,000
MF8600 6.66	94826					7,000
MF8600 6.67	94827					7,000
MF8600 6.68	94828					7,000
MF8600 6.69	94829					7,000
MF8600 6.70	94830					7,000
MF8600 6.71	94831					9,900
MF8600 6.72	94832					9,900
MF8600 6.73	94833					9,900
MF8600 6.74	94834					9,900
MF8600 6.75	94835					9,900
MF8600 6.76	94836					9,900
MF8600 6.77	94837					9,900
MF8600 6.78	94838					9,900
MF8600 6.79	94839	9,900				
MF8600 6.80	94840	9,900				
MF8600 6.81	94841	9,900				
MF8600 6.82	94842	9,900				
MF8600 6.83	94843	9,900				
MF8600 6.84	94844	9,900				
MF8600 6.85	94845	9,900				
MF8600 6.86	94846	9,900				
MF8600 6.87	94847	9,900				
MF8600 6.88	94848	9,900				
MF8600 6.89	94849	9,900				
MF8600 6.90	94850	109	31	80	7.0	9,900
MF8600 6.91	94851	9,900				
MF8600 6.92	94852	9,900				
MF8600 6.93	94853	9,900				
MF8600 6.94	94854	9,900				
MF8600 6.95	94855	9,900				
MF8600 6.96	94856	9,900				
MF8600 6.97	94857	9,900				
MF8600 6.98	94858	9,900				
MF8600 6.99	94859	9,900				
MF8600 7.00	94860	9,900				
MF8600 7.01	94861	9,900				
MF8600 7.02	94862	9,900				
MF8600 7.03	94863	9,900				
MF8600 7.04	94864	9,900				
MF8600 7.05	94865	9,900				
MF8600 7.06	94866	9,900				
MF8600 7.07	94867	9,900				
MF8600 7.08	94868	9,900				
MF8600 7.09	94869	9,900				

MF8600

型番	WEBコード	L	φ1	φ2	d	価格
MF8600 7.10	94870	109	31	80	7.0	9,900
MF8600 7.11	94871					9,900
MF8600 7.12	94872					9,900
MF8600 7.13	94873					9,900
MF8600 7.14	94874					9,900
MF8600 7.15	94875					9,900
MF8600 7.16	94876					9,900
MF8600 7.17	94877					9,900
MF8600 7.18	94878					9,900
MF8600 7.19	94879					9,900
MF8600 7.20	94880					9,900
MF8600 7.21	94881					9,900
MF8600 7.22	94882					9,900
MF8600 7.23	94883					9,900
MF8600 7.24	94884					9,900
MF8600 7.25	94885					9,900
MF8600 7.26	94886					9,900
MF8600 7.27	94887					9,900
MF8600 7.28	94888					9,900
MF8600 7.29	94889	9,900				
MF8600 7.30	94890	9,900				
MF8600 7.31	94891	9,900				
MF8600 7.32	94892	9,900				
MF8600 7.33	94893	9,900				
MF8600 7.34	94894	9,900				
MF8600 7.35	94895	9,900				
MF8600 7.36	94896	9,900				
MF8600 7.37	94897	9,900				
MF8600 7.38	94898	9,900				
MF8600 7.39	94899	9,900				
MF8600 7.40	94900	9,900				
MF8600 7.41	94901	9,900				
MF8600 7.42	94902	9,900				
MF8600 7.43	94903	9,900				
MF8600 7.44	94904	9,900				
MF8600 7.45	94905	9,900				
MF8600 7.46	94906	9,900				
MF8600 7.47	94907	9,900				
MF8600 7.48	94908	9,900				
MF8600 7.49	94909	9,900				
MF8600 7.50	94910	9,900				
MF8600 7.51	94911	9,900				
MF8600 7.52	94912	9,900				
MF8600 7.53	94913	9,900				
MF8600 7.54	94914	9,900				
MF8600 7.55	94915	9,900				
MF8600 7.56	94916	9,900				
MF8600 7.57	94917	117	33	86	8.0	9,900
MF8600 7.58	94918	9,900				
MF8600 7.59	94919	9,900				

※ φ0.6~13.05 超硬ソリッドタイプ φ13.97~20.05 超硬ろう付タイプ

※ 在庫なくなり次第、取寄せ品となります。

マシンリーマ

各サイズ最大0~+0.005公差で各種穴仕上げ寸法に対応!

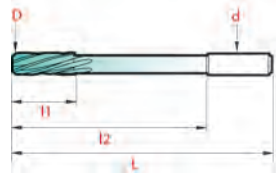

超硬 K15
ネジレ角 左10°
食付角 45°

公差	D				d		l ₁ L		刃数	
	D	d	l ₁	L	Z	φ	Z	φ		
0.60~3.00	0,+0.003	h6	+1	±1	4	0.60~2.36	6	2.37~13.05		
3.01~6.00	0,+0.004	h6	+1	±1	6	2.37~13.05	8	13.97~20.05		
6.01~20.2	0,+0.005	h6	+1	±1	8	13.97~20.05				

MF8600

型番	WEBコード	L	φ1	φ2	d	価格
MF8600 7.60	94920					9,900
MF8600 7.61	94921					9,900
MF8600 7.62	94922					9,900
MF8600 7.63	94923					9,900
MF8600 7.64	94924					9,900
MF8600 7.65	94925					9,900
MF8600 7.66	94926					9,900
MF8600 7.67	94927					9,900
MF8600 7.68	94928					9,900
MF8600 7.69	94929					9,900
MF8600 7.70	94930					9,900
MF8600 7.71	94931					9,900
MF8600 7.72	94932					9,900
MF8600 7.73	94933					9,900
MF8600 7.74	94934					9,900
MF8600 7.75	94935					9,900
MF8600 7.76	94936					9,900
MF8600 7.77	94937					9,900
MF8600 7.78	94938					9,900
MF8600 7.79	94939					9,900
MF8600 7.80	94940					9,900
MF8600 7.81	94941					9,900
MF8600 7.82	94942					9,900
MF8600 7.83	94943					9,900
MF8600 7.84	94944					9,900
MF8600 7.85	94945	117	33	86	8.0	9,900
MF8600 7.86	94946					9,900
MF8600 7.87	94947					9,900
MF8600 7.88	94948					9,900
MF8600 7.89	94949					9,900
MF8600 7.90	94950					9,900
MF8600 7.91	94951					9,900
MF8600 7.92	94952					9,900
MF8600 7.93	94953					9,900
MF8600 7.94	94954					9,900
MF8600 7.95	94955					9,900
MF8600 7.96	94956					9,900
MF8600 7.97	94957					9,900
MF8600 7.98	94958					9,900
MF8600 7.99	94959					9,900
MF8600 8.00	94960					9,900
MF8600 8.01	94961					9,900
MF8600 8.02	94962					9,900
MF8600 8.03	94963					9,900
MF8600 8.04	94964					9,900
MF8600 8.05	94965					9,900
MF8600 8.06	94966					9,900
MF8600 8.07	94967					9,900
MF8600 8.08	94968					9,900
MF8600 8.09	94969					9,900

MF8600

型番	WEBコード	L	φ1	φ2	d	価格
MF8600 8.10	94970					9,900
MF8600 8.11	94971					9,900
MF8600 8.12	94972					9,900
MF8600 8.13	94973					9,900
MF8600 8.14	94974					9,900
MF8600 8.15	94975					9,900
MF8600 8.16	94976					9,900
MF8600 8.17	94977					9,900
MF8600 8.18	94978					9,900
MF8600 8.19	94979					9,900
MF8600 8.20	94980					9,900
MF8600 8.21	94981					9,900
MF8600 8.22	94982					9,900
MF8600 8.23	94983					9,900
MF8600 8.24	94984					9,900
MF8600 8.25	94985					9,900
MF8600 8.26	94986					9,900
MF8600 8.27	94987					9,900
MF8600 8.28	94988					9,900
MF8600 8.29	94989					9,900
MF8600 8.30	94990					9,900
MF8600 8.31	94991					9,900
MF8600 8.32	94992					9,900
MF8600 8.33	94993	117	33	86	8.0	9,900
MF8600 8.34	94994					9,900
MF8600 8.35	94995					9,900
MF8600 8.36	94996					9,900
MF8600 8.37	94997					9,900
MF8600 8.38	94998					9,900
MF8600 8.39	94999					9,900
MF8600 8.40	95000					9,900
MF8600 8.41	95001					9,900
MF8600 8.42	95002					9,900
MF8600 8.43	95003					9,900
MF8600 8.44	95004					9,900
MF8600 8.45	95005					9,900
MF8600 8.46	95006					9,900
MF8600 8.47	95007					9,900
MF8600 8.48	95008					9,900
MF8600 8.49	95009					9,900
MF8600 8.50	95010					9,900
MF8600 8.51	95011					10,890
MF8600 8.52	95012					10,890
MF8600 8.53	95013					10,890
MF8600 8.54	95014					10,890
MF8600 8.55	95015					10,890
MF8600 8.56	95016					13,440
MF8600 8.57	95017	125	36	91	9.0	13,440
MF8600 8.58	95018					13,440
MF8600 8.59	95019					13,440

※ φ0.6 ~ 13.05 超硬ソリッドタイプ φ13.97 ~ 20.05 超硬ろう付タイプ

※ 在庫なくなり次第、取寄せ品となります。

マシンリーマ

マシンリーマ

各サイズ最大0~+0.005公差で各種穴仕上げ寸法に対応!

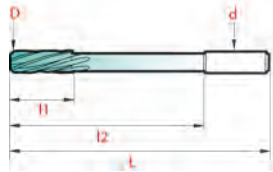

超硬 K15
ネジレ角 左10°
食付角 45°

公差	D				d		l ₁		L		刃数	
	Z	φ	Z	φ	Z	φ	Z	φ	Z	φ	Z	φ
0.60~3.00	0,+0.003	h6	+1	±1	4	0.60~2.36	6	2.37~13.05	8	13.97~20.05		
3.01~6.00	0,+0.004	h6	+1	±1								
6.01~20.2	0,+0.005	h6	+1	±1								

MF8600

型番	WEBコード	L	φ1	φ2	d	価格
MF8600 8.60	95020					13,440
MF8600 8.61	95021					13,440
MF8600 8.62	95022					13,440
MF8600 8.63	95023					13,440
MF8600 8.64	95024					13,440
MF8600 8.65	95025					13,440
MF8600 8.66	95026					13,440
MF8600 8.67	95027					13,440
MF8600 8.68	95028					13,440
MF8600 8.69	95029					13,440
MF8600 8.70	95030					13,440
MF8600 8.71	95031					13,440
MF8600 8.72	95032					13,440
MF8600 8.73	95033					13,440
MF8600 8.74	95034					13,440
MF8600 8.75	95035					13,440
MF8600 8.76	95036					13,440
MF8600 8.77	95037					13,440
MF8600 8.78	95038					13,440
MF8600 8.79	95039					13,440
MF8600 8.80	95040					13,440
MF8600 8.81	95041					13,440
MF8600 8.82	95042					13,440
MF8600 8.83	95043					13,440
MF8600 8.84	95044	125	36	91	9.0	13,440
MF8600 8.85	95045					13,440
MF8600 8.86	95046					13,440
MF8600 8.87	95047					13,440
MF8600 8.88	95048					13,440
MF8600 8.89	95049					13,440
MF8600 8.90	95050					13,440
MF8600 8.91	95051					13,440
MF8600 8.92	95052					13,440
MF8600 8.93	95053					13,440
MF8600 8.94	95054					13,440
MF8600 8.95	95055					13,440
MF8600 8.96	95056					13,440
MF8600 8.97	95057					13,440
MF8600 8.98	95058					13,440
MF8600 8.99	95059					13,440
MF8600 9.00	95060					13,440
MF8600 9.01	95061					13,440
MF8600 9.02	95062					13,440
MF8600 9.03	95063					13,440
MF8600 9.04	95064					13,440
MF8600 9.05	95065					13,440
MF8600 9.06	95066					13,440
MF8600 9.07	95067					13,440
MF8600 9.08	95068					13,440
MF8600 9.09	95069					13,440

※ φ0.6~13.05 超硬ソリッドタイプ φ13.97~20.05 超硬ろう付タイプ

MF8600

型番	WEBコード	L	φ1	φ2	d	価格
MF8600 9.10	95070					13,440
MF8600 9.11	95071					13,440
MF8600 9.12	95072					13,440
MF8600 9.13	95073					13,440
MF8600 9.14	95074					13,440
MF8600 9.15	95075					13,440
MF8600 9.16	95076					13,440
MF8600 9.17	95077					13,440
MF8600 9.18	95078					13,440
MF8600 9.19	95079					13,440
MF8600 9.20	95080					13,440
MF8600 9.21	95081					13,440
MF8600 9.22	95082					13,440
MF8600 9.23	95083					13,440
MF8600 9.24	95084					13,440
MF8600 9.25	95085					13,440
MF8600 9.26	95086					13,440
MF8600 9.27	95087					13,440
MF8600 9.28	95088					13,440
MF8600 9.29	95089					13,440
MF8600 9.30	95090					13,440
MF8600 9.31	95091					13,440
MF8600 9.32	95092	125	36	91	9.0	13,440
MF8600 9.33	95093					13,440
MF8600 9.34	95094					13,440
MF8600 9.35	95095					13,440
MF8600 9.36	95096					13,440
MF8600 9.37	95097					13,440
MF8600 9.38	95098					13,440
MF8600 9.39	95099					13,440
MF8600 9.40	95100					13,440
MF8600 9.41	95101					13,440
MF8600 9.42	95102					13,440
MF8600 9.43	95103					13,440
MF8600 9.44	95104					13,440
MF8600 9.45	95105					13,440
MF8600 9.46	95106					13,440
MF8600 9.47	95107					13,440
MF8600 9.48	95108					13,440
MF8600 9.49	95109					13,440
MF8600 9.50	95110					13,440
MF8600 9.51	95111					13,440
MF8600 9.52	95112					13,440
MF8600 9.53	95113					13,440
MF8600 9.54	95114					13,440
MF8600 9.55	95115					13,440
MF8600 9.56	95116					13,440
MF8600 9.57	95117	133	38	99	10.0	13,440
MF8600 9.58	95118					13,440
MF8600 9.59	95119					13,440

※ 在庫なくなり次第、取寄せ品となります。

マシンリーマ

各サイズ最大0~+0.005公差で各種穴仕上げ寸法に対応!

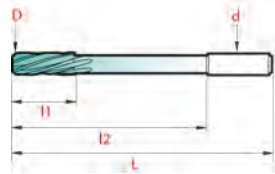

超硬 K15
ネジレ角 左10°
食付角 45°

公差	D				d		l ₁		L		刃数	
	Z	φ	Z	φ	Z	φ	Z	φ	Z	φ	Z	φ
0.60~3.00	0,+0.003	h6	+1	±1	4	0.60~2.36	6	2.37~13.05	8	13.97~20.05		
3.01~6.00	0,+0.004	h6	+1	±1								
6.01~20.2	0,+0.005	h6	+1	±1								

MF8600

型番	WEBコード	L	φ1	φ2	d	価格
MF8600 9.60	95120					13,440
MF8600 9.61	95121					13,440
MF8600 9.62	95122					13,440
MF8600 9.63	95123					13,440
MF8600 9.64	95124					13,440
MF8600 9.65	95125					13,440
MF8600 9.66	95126					13,440
MF8600 9.67	95127					13,440
MF8600 9.68	95128					13,440
MF8600 9.69	95129					13,440
MF8600 9.70	95130					13,440
MF8600 9.71	95131					13,440
MF8600 9.72	95132					13,440
MF8600 9.73	95133					13,440
MF8600 9.74	95134					13,440
MF8600 9.75	95135					13,440
MF8600 9.76	95136					13,440
MF8600 9.77	95137					13,440
MF8600 9.78	95138					13,440
MF8600 9.79	95139					13,440
MF8600 9.80	95140					13,440
MF8600 9.81	95141					13,440
MF8600 9.82	95142					13,440
MF8600 9.83	95143					13,440
MF8600 9.84	95144	133	38	99	10.0	13,440
MF8600 9.85	95145					13,440
MF8600 9.86	95146					13,440
MF8600 9.87	95147					13,440
MF8600 9.88	95148					13,440
MF8600 9.89	95149					13,440
MF8600 9.90	95150					13,440
MF8600 9.91	95151					13,440
MF8600 9.92	95152					13,440
MF8600 9.93	95153					13,440
MF8600 9.94	95154					13,440
MF8600 9.95	95155					13,440
MF8600 9.96	95156					13,440
MF8600 9.97	95157					13,440
MF8600 9.98	95158					13,440
MF8600 9.99	95159					13,440
MF8600 10.00	95160					13,440
MF8600 10.01	95161					13,440
MF8600 10.02	95162					13,440
MF8600 10.03	95163					13,440
MF8600 10.04	95164					13,440
MF8600 10.05	95165					13,440
MF8600 10.06	95166					15,800
MF8600 10.07	95167					15,800
MF8600 10.08	95168					15,800
MF8600 10.09	95169					15,800

MF8600

型番	WEBコード	L	φ1	φ2	d	価格
MF8600 10.10	95170					15,800
MF8600 10.11	95171					15,800
MF8600 10.12	95172					15,800
MF8600 10.13	95173					15,800
MF8600 10.14	95174					15,800
MF8600 10.15	95175					15,800
MF8600 10.16	95176					15,800
MF8600 10.17	95177					15,800
MF8600 10.18	95178					15,800
MF8600 10.19	95179					15,800
MF8600 10.20	95180					15,800
MF8600 10.21	95181					15,800
MF8600 10.22	95182					15,800
MF8600 10.23	95183					15,800
MF8600 10.24	95184					15,800
MF8600 10.25	95185					15,800
MF8600 10.26	95186					15,800
MF8600 10.27	95187					15,800
MF8600 10.28	95188					15,800
MF8600 10.29	95189					15,800
MF8600 10.30	95190					15,800
MF8600 10.31	95191					15,800
MF8600 10.32	95192					15,800
MF8600 10.33	95193					15,800
MF8600 10.34	95194	133	38	99	10.0	15,800
MF8600 10.35	95195					15,800
MF8600 10.36	95196					15,800
MF8600 10.37	95197					15,800
MF8600 10.38	95198					15,800
MF8600 10.39	95199					15,800
MF8600 10.40	95200					15,800
MF8600 10.41	95201					15,800
MF8600 10.42	95202					15,800
MF8600 10.43	95203					15,800
MF8600 10.44	95204					15,800
MF8600 10.45	95205					15,800
MF8600 10.46	95206					15,800
MF8600 10.47	95207					15,800
MF8600 10.48	95208					15,800
MF8600 10.49	95209					15,800
MF8600 10.50	95210					15,800
MF8600 10.51	95211					15,800
MF8600 10.52	95212					15,800
MF8600 10.53	95213					15,800
MF8600 10.54	95214					15,800
MF8600 10.55	95215					15,800
MF8600 10.56	95216					15,800
MF8600 10.57	95217					15,800
MF8600 10.58	95218					15,800
MF8600 10.59	95219					15,800

※ φ0.6 ~ 13.05 超硬ソリッドタイプ φ13.97 ~ 20.05 超硬ろう付タイプ

※ 在庫なくなり次第、取寄せ品となります。

マシンリーマ

マシンリーマ

各サイズ最大0~+0.005公差で各種穴仕上げ寸法に対応!

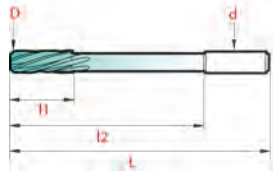

超硬 K15
ネジレ角 左10°
食付角 45°

公差	D				d		l ₁		L		刃数	
	Z	φ	Z	φ	Z	φ	Z	φ	Z	φ	Z	φ
0.60~3.00	0,+0.003	h6	+1	±1	4	0.60~2.36	6	2.37~13.05	8	13.97~20.05		
3.01~6.00	0,+0.004	h6	+1	±1								
6.01~20.2	0,+0.005	h6	+1	±1								

MF8600

型番	WEBコード	L	φ1	φ2	d	価格
MF8600 10.60	95220					15,800
MF8600 10.61	95221					15,800
MF8600 10.62	95222					15,800
MF8600 10.63	95223					15,800
MF8600 10.64	95224					15,800
MF8600 10.65	95225					15,800
MF8600 10.66	95226					15,800
MF8600 10.67	95227					15,800
MF8600 10.68	95228					15,800
MF8600 10.69	95229					15,800
MF8600 10.70	95230					15,800
MF8600 10.71	95231					15,800
MF8600 10.72	95232					15,800
MF8600 10.73	95233					15,800
MF8600 10.74	95234					15,800
MF8600 10.75	95235					15,800
MF8600 10.76	95236					15,800
MF8600 10.77	95237					15,800
MF8600 10.78	95238					15,800
MF8600 10.79	95239					15,800
MF8600 10.80	95240					15,800
MF8600 10.81	95241					15,800
MF8600 10.82	95242					15,800
MF8600 10.83	95243					15,800
MF8600 10.84	95244					15,800
MF8600 10.85	95245	133	38	99	10.0	15,800
MF8600 10.86	95246					15,800
MF8600 10.87	95247					15,800
MF8600 10.88	95248					15,800
MF8600 10.89	95249					15,800
MF8600 10.90	95250					15,800
MF8600 10.91	95251					15,800
MF8600 10.92	95252					15,800
MF8600 10.93	95253					15,800
MF8600 10.94	95254					15,800
MF8600 10.95	95255					15,800
MF8600 10.96	95256					15,800
MF8600 10.97	95257					15,800
MF8600 10.98	95258					15,800
MF8600 10.99	95259					15,800
MF8600 11.00	95260					15,800
MF8600 11.01	95261					15,800
MF8600 11.02	95262					15,800
MF8600 11.03	95263					15,800
MF8600 11.04	95264					15,800
MF8600 11.05	95265					15,800
MF8600 11.06	95266					17,380
MF8600 11.07	95267					17,380
MF8600 11.08	95268					17,380
MF8600 11.09	95269					17,380

※ φ0.6~13.05 超硬ソリッドタイプ φ13.97~20.05 超硬ろう付タイプ

MF8600

型番	WEBコード	L	φ1	φ2	d	価格
MF8600 11.10	95270					17,380
MF8600 11.11	95271					17,380
MF8600 11.12	95272					17,380
MF8600 11.13	95273					17,380
MF8600 11.14	95274					17,380
MF8600 11.15	95275					17,380
MF8600 11.16	95276					17,380
MF8600 11.17	95277					17,380
MF8600 11.18	95278					17,380
MF8600 11.19	95279					17,380
MF8600 11.20	95280	133	38	99	10.0	17,380
MF8600 11.21	95281					17,380
MF8600 11.22	95282					17,380
MF8600 11.23	95283					17,380
MF8600 11.24	95284					17,380
MF8600 11.25	95285					17,380
MF8600 11.26	95286					17,380
MF8600 11.27	95287					17,380
MF8600 11.28	95288					17,380
MF8600 11.29	95289					17,380
MF8600 11.30	95290					17,380
MF8600 11.31	95291					17,380
MF8600 11.32	95292					17,380
MF8600 11.33	95293					17,380
MF8600 11.34	95294					17,380
MF8600 11.35	95295					17,380
MF8600 11.36	95296					17,380
MF8600 11.37	95297					17,380
MF8600 11.38	95298					17,380
MF8600 11.39	95299					17,380
MF8600 11.40	95300					17,380
MF8600 11.41	95301					17,380
MF8600 11.42	95302					17,380
MF8600 11.43	95303					17,380
MF8600 11.44	95304					17,380
MF8600 11.45	95305	151	44	106	12.0	17,380
MF8600 11.46	95306					17,380
MF8600 11.47	95307					17,380
MF8600 11.48	95308					17,380
MF8600 11.49	95309					17,380
MF8600 11.50	95310					17,380
MF8600 11.51	95311					17,380
MF8600 11.52	95312					17,380
MF8600 11.53	95313					17,380
MF8600 11.54	95314					17,380
MF8600 11.55	95315					17,380
MF8600 11.56	95316					17,380
MF8600 11.57	95317					17,380
MF8600 11.58	95318					17,380
MF8600 11.59	95319					17,380

※ 在庫なくなり次第、取寄せ品となります。

マシンリーマ

各サイズ最大0~+0.005公差で各種穴仕上げ寸法に対応!

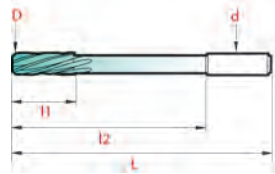

超硬 K15
ネジレ角 左10°
食付角 45°

公差	D				d		l ₁		L		刃数	
	Z	φ	Z	φ	Z	φ	Z	φ	Z	φ	Z	φ
0.60~3.00	0,+0.003	h6	+1	±1	4	0.60~2.36	6	2.37~13.05	8	13.97~20.05		
3.01~6.00	0,+0.004	h6	+1	±1								
6.01~20.2	0,+0.005	h6	+1	±1								

MF8600

型番	WEBコード	L	φ1	φ2	d	価格
MF8600 11.60	95320					17,380
MF8600 11.61	95321					17,380
MF8600 11.62	95322					17,380
MF8600 11.63	95323					17,380
MF8600 11.64	95324					17,380
MF8600 11.65	95325					17,380
MF8600 11.66	95326					17,380
MF8600 11.67	95327					17,380
MF8600 11.68	95328					17,380
MF8600 11.69	95329					17,380
MF8600 11.70	95330					17,380
MF8600 11.71	95331					17,380
MF8600 11.72	95332					17,380
MF8600 11.73	95333					17,380
MF8600 11.74	95334					17,380
MF8600 11.75	95335					17,380
MF8600 11.76	95336					17,380
MF8600 11.77	95337					17,380
MF8600 11.78	95338					17,380
MF8600 11.79	95339					17,380
MF8600 11.80	95340					17,380
MF8600 11.81	95341					17,380
MF8600 11.82	95342					17,380
MF8600 11.83	95343					17,380
MF8600 11.84	95344					17,380
MF8600 11.85	95345	151	44	106	12.0	17,380
MF8600 11.86	95346					17,380
MF8600 11.87	95347					17,380
MF8600 11.88	95348					17,380
MF8600 11.89	95349					17,380
MF8600 11.90	95350					17,380
MF8600 11.91	95351					17,380
MF8600 11.92	95352					17,380
MF8600 11.93	95353					17,380
MF8600 11.94	95354					17,380
MF8600 11.95	95355					17,380
MF8600 11.96	95356					17,380
MF8600 11.97	95357					17,380
MF8600 11.98	95358					17,380
MF8600 11.99	95359					17,380
MF8600 12.00	95360					17,380
MF8600 12.01	95361					17,380
MF8600 12.02	95362					17,380
MF8600 12.03	95363					17,380
MF8600 12.04	95364					17,380
MF8600 12.05	95365					17,380
MF8600 12.06	95366					21,500
MF8600 12.07	95367					21,500
MF8600 12.08	95368					21,500
MF8600 12.09	95369					21,500

MF8600

型番	WEBコード	L	φ1	φ2	d	価格
MF8600 12.10	95370					21,500
MF8600 12.11	95371					21,500
MF8600 12.12	95372					21,500
MF8600 12.13	95373					21,500
MF8600 12.14	95374					21,500
MF8600 12.15	95375					21,500
MF8600 12.16	95376					21,500
MF8600 12.17	95377					21,500
MF8600 12.18	95378					21,500
MF8600 12.19	95379					21,500
MF8600 12.20	95380					21,500
MF8600 12.21	95381					21,500
MF8600 12.22	95382					21,500
MF8600 12.23	95383					21,500
MF8600 12.24	95384					21,500
MF8600 12.25	95385					21,500
MF8600 12.26	95386					21,500
MF8600 12.27	95387					21,500
MF8600 12.28	95388					21,500
MF8600 12.29	95389					21,500
MF8600 12.30	95390					21,500
MF8600 12.31	95391					21,500
MF8600 12.32	95392					21,500
MF8600 12.33	95393					21,500
MF8600 12.34	95394					21,500
MF8600 12.35	95395	151	44	106	12.0	21,500
MF8600 12.36	95396					21,500
MF8600 12.37	95397					21,500
MF8600 12.38	95398					21,500
MF8600 12.39	95399					21,500
MF8600 12.40	95400					21,500
MF8600 12.41	95401					21,500
MF8600 12.42	95402					21,500
MF8600 12.43	95403					21,500
MF8600 12.44	95404					21,500
MF8600 12.45	95405					21,500
MF8600 12.46	95406					21,500
MF8600 12.47	95407					21,500
MF8600 12.48	95408					21,500
MF8600 12.49	95409					21,500
MF8600 12.50	95410					21,500
MF8600 12.51	95411					21,500
MF8600 12.52	95412					21,500
MF8600 12.53	95413					21,500
MF8600 12.54	95414					21,500
MF8600 12.55	95415					21,500
MF8600 12.56	95416					21,500
MF8600 12.57	95417					21,500
MF8600 12.58	95418					21,500
MF8600 12.59	95419					21,500

※ φ0.6~13.05 超硬ソリッドタイプ φ13.97~20.05 超硬ろう付タイプ

※ 在庫なくなり次第、取寄せ品となります。

マシンリーマ

マシンリーマ

各サイズ最大0~+0.005公差で各種穴仕上げ寸法に対応!

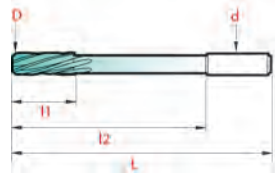

超硬 K15
ネジレ角 左10°
食付角 45°

公差	D				d		刃数	
	D	d	l ₁	L	Z	φ		
0.60~3.00	0,+0.003	h6	+1	±1	4	0.60~2.36		
3.01~6.00	0,+0.004	h6	+1	±1	6	2.37~13.05		
6.01~20.2	0,+0.005	h6	+1	±1	8	13.97~20.05		

MF8600

型番	WEBコード	L	φ1	φ2	d	価格
MF8600 12.60	95420	151	44	106	12.0	21,500
MF8600 12.61	95421					21,500
MF8600 12.62	95422					21,500
MF8600 12.63	95423					21,500
MF8600 12.64	95424					21,500
MF8600 12.65	95425					21,500
MF8600 12.66	95426					21,500
MF8600 12.67	95427					21,500
MF8600 12.68	95428					21,500
MF8600 12.69	95429					21,500
MF8600 12.70	95430					21,500
MF8600 12.71	95431					21,500
MF8600 12.72	95432					21,500
MF8600 12.73	95433					21,500
MF8600 12.74	95434					21,500
MF8600 12.75	95435					21,500
MF8600 12.76	95436					21,500
MF8600 12.77	95437					21,500
MF8600 12.78	95438					21,500
MF8600 12.79	95439					21,500
MF8600 12.80	95440					21,500
MF8600 12.81	95441					21,500
MF8600 12.82	95442					21,500
MF8600 12.83	95443					21,500
MF8600 12.84	95444					21,500
MF8600 12.85	95445					21,500
MF8600 12.86	95446					21,500
MF8600 12.87	95447	21,500				
MF8600 12.88	95448	21,500				
MF8600 12.89	95449	21,500				
MF8600 12.90	95450	21,500				
MF8600 12.91	95451	21,500				
MF8600 12.92	95452	21,500				
MF8600 12.93	95453	21,500				
MF8600 12.94	95454	21,500				
MF8600 12.95	95455	21,500				
MF8600 12.96	95456	21,500				
MF8600 12.97	95457	21,500				
MF8600 12.98	95458	21,500				
MF8600 12.99	95459	21,500				
MF8600 13.00	95460	21,500				
MF8600 13.01	95461	21,500				
MF8600 13.02	95462	21,500				
MF8600 13.03	95463	21,500				
MF8600 13.04	95464	21,500				
MF8600 13.05	95465	21,500				
MF8600 13.97	95466	160	47	110	14.0	29,120
MF8600 13.98	95467					29,120
MF8600 13.99	95468					29,120
MF8600 14.00	95469					29,120
MF8600 14.01	95470					29,120

MF8600

型番	WEBコード	L	φ1	φ2	d	価格				
MF8600 14.01	95470	160	47	110	14.0	29,120				
MF8600 14.02	95471					29,120				
MF8600 14.03	95472					29,120				
MF8600 14.04	95473					29,120				
MF8600 14.05	95474					29,120				
MF8600 14.97	95475					162	50	112	14.0	32,470
MF8600 14.98	95476									32,470
MF8600 14.99	95477									32,470
MF8600 15.00	95478									32,470
MF8600 15.01	95479									32,470
MF8600 15.02	95480	32,470								
MF8600 15.03	95481	32,470								
MF8600 15.04	95482	32,470								
MF8600 15.05	95483	32,470								
MF8600 15.97	95484	170	52	117	16.0					33,590
MF8600 15.98	95485					33,590				
MF8600 15.99	95486					33,590				
MF8600 16.00	95487					33,590				
MF8600 16.01	95488					33,590				
MF8600 16.02	95489					33,590				
MF8600 16.03	95490					33,590				
MF8600 16.04	95491					33,590				
MF8600 16.05	95492					33,590				
MF8600 17.97	95493					182	56	129	16.0	40,310
MF8600 17.98	95494	40,310								
MF8600 17.99	95495	40,310								
MF8600 18.00	95496	40,310								
MF8600 18.01	95497	40,310								
MF8600 18.02	95498	40,310								
MF8600 18.03	95499	40,310								
MF8600 18.04	95500	40,310								
MF8600 18.05	95501	40,310								
MF8600 19.97	95502	195	60	142	16.0					51,510
MF8600 19.98	95503					51,510				
MF8600 19.99	95504					51,510				
MF8600 20.00	95505					51,510				
MF8600 20.01	95506					51,510				
MF8600 20.02	95507	51,510								
MF8600 20.03	95508	51,510								
MF8600 20.04	95509	51,510								
MF8600 20.05	95510	51,510								

※ 在庫なくなり次第、取寄せ品となります。

※ φ0.6~13.05 超硬ソリッドタイプ φ13.97~20.05 超硬ろう付タイプ

マシンリーマ

H7公差対応のスタンダードリーマ！



H7	HSS Co	ネジレ角 左10°	食付角 45°
-----------	---------------	--------------	------------

公差				刃数	
D	d	l ₁	L	Z	φ
H7	h8	+1	±1	4	1.0
				6	1.1~125
				8	130~200

MF650

型番	WEBコード	L	φ1(min)	φ2	d	価格
MF650 1.0	MA001	38	5	22	D	3,360
MF650 1.1	MA174					3,470
MF650 1.2	MA175					3,470
MF650 1.3	MA176	40	7	24		3,470
MF650 1.4	MA177					3,470
MF650 1.5	MA002					3,030
MF650 1.6	MA178					3,360
MF650 1.7	MA179	43	9			3,360
MF650 1.8	MA180					3,360
MF650 1.9	MA181	49→46	10			3,360
MF650 2.0	MA003					2,800
MF650 2.1	MA182	49	11	31		3,020
MF650 2.2	MA183					3,020
MF650 2.3	MA184	49→53	12			3,020
MF650 2.4	MA185					3,020
MF650 2.5	MA004	57	14			2,520
MF650 2.6	MA186					2,690
MF650 2.7	MA187					2,690
MF650 2.8	MA188					2,690
MF650 2.9	MA189	57→61	15			2,690
MF650 3.0	MA005			36		2,520
MF650 3.1	MA190					2,690
MF650 3.2	MA191	57→65	16			2,690
MF650 3.3	MA192					2,690
MF650 3.4	MA193				2,690	
MF650 3.5	MA006	57→70	18		2,520	
MF650 3.6	MA194				2,800	
MF650 3.7	MA195				2,800	
MF650 3.8	MA196				2,800	
MF650 3.9	MA197				2,800	
MF650 4.0	MA007	75	19	47	4.0	2,690
MF650 4.1	MA198					3,030
MF650 4.2	MA199					3,030
MF650 4.3	MA200					3,030
MF650 4.4	MA201					3,030
MF650 4.5	MA008	80	21	52	4.5→5.0	2,690
MF650 4.6	MA202					3,030
MF650 4.7	MA203					3,030
MF650 4.8	MA204					3,030
MF650 4.9	MA205					3,030
MF650 5.0	MA009					2,800
MF650 5.1	MA206	86	23		5.0	3,020
MF650 5.2	MA207					3,020
MF650 5.3	MA208					3,020
MF650 5.4	MA209			58		3,020
MF650 5.5	MA010					2,910
MF650 5.6	MA210	93			5.5→5.6	3,020
MF650 5.7	MA211		26			3,020
MF650 5.8	MA212					3,020
MF650 5.9	MA213	101→93			6.0→5.6	3,020

MF650

型番	WEBコード	L	φ1(min)	φ2	d	価格
MF650 6.0	MA011	101→93	26	58	6.0→5.6	2,940
MF650 6.1	MA214					3,020
MF650 6.2	MA215					3,020
MF650 6.3	MA216					3,020
MF650 6.4	MA217	101	28	65	6.0→6.3	3,020
MF650 6.5	MA012					2,940
MF650 6.6	MA218					3,700
MF650 6.7	MA219					3,700
MF650 6.8	MA220					3,700
MF650 6.9	MA221					3,700
MF650 7.0	MA013					3,470
MF650 7.1	MA222	109	31	73	7.0→7.1	3,700
MF650 7.2	MA223					3,700
MF650 7.3	MA224					3,700
MF650 7.4	MA225					3,700
MF650 7.5	MA014				7.0	3,470
MF650 7.6	MA226					3,920
MF650 7.7	MA227					3,920
MF650 7.8	MA228					3,920
MF650 7.9	MA229					3,920
MF650 8.0	MA015	117	33	81	8.0	3,580
MF650 8.1	MA230					3,920
MF650 8.2	MA231					3,920
MF650 8.3	MA232					3,920
MF650 8.4	MA233					3,920
MF650 8.5	MA016					3,580
MF650 8.6	MA234					4,700
MF650 8.7	MA235					4,700
MF650 8.8	MA236					4,700
MF650 8.9	MA237					4,700
MF650 9.0	MA017	125	36	85	9.0	3,690
MF650 9.1	MA238					4,700
MF650 9.2	MA239					4,700
MF650 9.3	MA240					4,700
MF650 9.4	MA241					4,700
MF650 9.5	MA018	125→133			9.0→10.0	3,690
MF650 9.6	MA242					4,700
MF650 9.7	MA243					4,700
MF650 9.8	MA244					4,700
MF650 9.9	MA245					4,700
MF650 10.0	MA019					4,360
MF650 10.1	MA246	133	38	93	10.0	4,920
MF650 10.2	MA247					4,920
MF650 10.3	MA248					4,920
MF650 10.4	MA249					4,920
MF650 10.5	MA020					4,290
MF650 10.6	MA250					4,920
MF650 10.7	MA251					4,920
MF650 10.8	MA252	133→142	41	102		4,920
MF650 10.9	MA253					4,920

※ 在庫無くなり次第、取寄せ品となります。
 ※ 取寄せ品においては一部寸法が変更になっています。(表中の“→”が変更寸法です)
 メーカー切り替え中の為、寸法については弊社窓口までお問い合わせください。

マシンリーマ

マシンリーマ

H7公差対応のスタンダードリーマ！

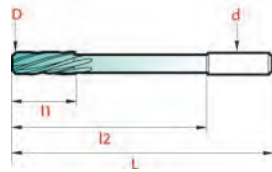

H7	HSS Co	ネジレ角 左10°	食付角 45°
-----------	---------------	--------------	------------

公差				刃数	
D	d	l ₁	L	Z	φ
H7	h8	+1	±1	4	1.0
				6	1.1~12.5
				8	13.0~20.0

MF650

型番	WEBコード	L	φ1(min)	φ2	d	価格
MF650 11.0	MA021	133→142	41	102	10.0	4,290
MF650 11.1	MA254					6,040
MF650 11.2	MA255					6,040
MF650 11.3	MA256					6,040
MF650 11.4	MA257					6,040
MF650 11.5	MA022	151→142	44	111	12.0→10.0	5,810
MF650 11.6	MA258					6,040
MF650 11.7	MA259					6,040
MF650 11.8	MA260					6,040
MF650 11.9	MA261					6,040
MF650 12.0	MA023	162	50	117	14.0→12.5	5,750
MF650 12.5	MA024					6,200
MF650 13.0	MA025					6,200
MF650 13.5	MA026					6,200
MF650 13.5	MA026					7,860

MF650

型番	WEBコード	L	φ1(min)	φ2	d	価格
MF650 14.0	MA027	162	50	117	14.0→12.5	7,860
MF650 14.5	MA028					9,110
MF650 15.0	MA029					9,110
MF650 15.5	MA030					9,330
MF650 16.0	MA031					9,330
MF650 16.5	MA032	175	54	130	16.0→12.5	11,520
MF650 17.0	MA033					11,520
MF650 17.5	MA034					11,760
MF650 18.0	MA035					11,760
MF650 18.5	MA036					12,650
MF650 19.0	MA037	182	56	137	16.0→14.0	12,650
MF650 19.5	MA038					12,940
MF650 20.0	MA039					12,940
MF650 20.0	MA039					12,940
MF650 20.0	MA039					12,940

※ 在庫なくなり次第、取寄せ品となります。

※ 取寄せ品においては一部寸法が変更になっています。(表中の“→”が変更寸法です) メーカー切り替え中の為、寸法については弊社窓口までお問い合わせください。

マシンリーマ

各サイズ最大0~+0.005公差で各種穴仕上げ寸法に対応！

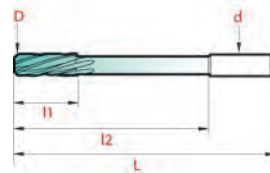

HSS Co	ネジレ角 左10°	食付角 45°
---------------	--------------	------------

公差				刃数	
D	d	l ₁	L	Z	φ
0.60~3.00	0,+0.003	h8	+1 ±1	4	0.60~1.05
3.01~6.00	0,+0.004	h8	+1 ±1	6	1.06~12.50
6.01~20.2	0,+0.005	h8	+1 ±1	8	12.51~20.2

MF600

型番	WEBコード	L	φ1(min)	φ2	d	価格
MF600 0.70	95511	33	5	22	D	4,100
MF600 0.80	95521	38				3,660
MF600 0.90	95531	40				3,660
MF600 0.97	95538	40				3,660
MF600 0.98	95539	40				3,660
MF600 0.99	95540	40				3,660
MF600 1.00	95541	40				3,660
MF600 1.01	95542	40				3,660
MF600 1.02	95543	40				3,660
MF600 1.10	95551	40				3,510
MF600 1.20	95561	40	3,510			
MF600 1.30	95571	40	3,510			
MF600 1.40	95581	40	3,510			
MF600 1.50	95591	40→43	3,410			
MF600 1.51	95592	40→43	3,410			
MF600 1.52	95593	40→43	3,410			
MF600 1.59	95600	43	3,250			
MF600 1.60	95601	43	3,250			
MF600 1.64	95605	43	3,250			
MF600 1.70	95611	43	3,250			
MF600 1.80	95621	49→46	3,070			
MF600 1.90	95631	49→46	3,070			

MF600

型番	WEBコード	L	φ1(min)	φ2	d	価格
MF600 1.97	95638	49	11	31	D	3,070
MF600 1.98	95639					3,070
MF600 1.99	95640					3,070
MF600 2.00	95641					3,070
MF600 2.01	95642					3,070
MF600 2.02	95643					3,070
MF600 2.10	95651					3,070
MF600 2.20	95661					3,070
MF600 2.30	95671					3,070
MF600 2.40	95681					2,770
MF600 2.48	95689	2,770				
MF600 2.49	95690	2,770				
MF600 2.50	95691	2,770				
MF600 2.51	95692	2,770				
MF600 2.52	95693	2,770				
MF600 2.60	95701	2,770				
MF600 2.70	95711	2,770				
MF600 2.80	95721	2,770				
MF600 2.90	95731	2,770				
MF600 2.97	95738	2,770				

※ 在庫なくなり次第、取寄せ品となります。

※ 取寄せ品においては一部寸法が変更になっています。(表中の“→”が変更寸法です) メーカー切り替え中の為、寸法については弊社窓口までお問い合わせください。

マシンリーマ

各サイズ最大0~+0.005公差で各種穴仕上げ寸法に対応！

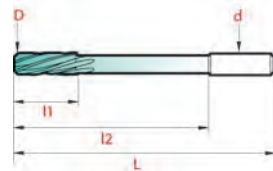

HSS Co ネジレ角 左10° 食付角 45°

公差	D	d	l ₁	L	刃数	
					Z	φ
0.60~3.00	0,+0.003	h8	+1	±1	4	0.60~1.05
3.01~6.00	0,+0.004	h8	+1	±1	6	1.06~12.50
6.01~20.2	0,+0.005	h8	+1	±1	8	12.51~20.2

MF600

型番	WEBコード	L	φ1(min)	φ2	d	価格
MF600 2.98	95739					2,770
MF600 2.99	95740	57→61	15			2,770
MF600 3.00	95741					2,770
MF600 3.01	95742					2,770
MF600 3.02	95743					2,770
MF600 3.10	95751	57→65	16	36	D	2,770
MF600 3.20	95761					2,770
MF600 3.30	95771					2,770
MF600 3.40	95781					2,770
MF600 3.50	95791	57→70	18			2,770
MF600 3.60	95801					2,770
MF600 3.70	95811					2,770
MF600 3.80	95821					2,880
MF600 3.90	95831					2,880
MF600 3.97	95838					2,880
MF600 3.98	95839					2,880
MF600 3.99	95840					2,880
MF600 4.00	95841	75	19	47	4.0	2,880
MF600 4.01	95842					2,880
MF600 4.02	95843					2,880
MF600 4.10	95851					2,880
MF600 4.20	95861					2,880
MF600 4.30	95871					2,920
MF600 4.40	95881					2,920
MF600 4.45	95886	80	21	52	4.5→5.0	2,920
MF600 4.50	95891					2,920
MF600 4.60	95901					2,920
MF600 4.70	95911					2,920
MF600 4.80	95921					3,020
MF600 4.90	95931					3,020
MF600 4.97	95938					3,020
MF600 4.98	95939					3,020
MF600 4.99	95940					3,020
MF600 5.00	95941	86	23		5.0	3,020
MF600 5.01	95942					3,020
MF600 5.02	95943					3,020
MF600 5.05	95946					3,020
MF600 5.10	95951					3,020
MF600 5.20	95961			58		3,020
MF600 5.30	95971					3,020
MF600 5.40	95981					3,250
MF600 5.50	95991					3,250
MF600 5.60	96001	93			5.5→5.6	3,250
MF600 5.70	96011					3,250
MF600 5.80	96021					3,250
MF600 5.90	96031					3,250
MF600 5.97	96038					3,250
MF600 5.98	96039	101→93			6.0→5.6	3,250
MF600 5.99	96040					3,250
MF600 6.00	96041					3,250
MF600 6.01	96042	101	28	65	6.0→6.3	3,250

MF600

型番	WEBコード	L	φ1(min)	φ2	d	価格
MF600 6.02	96043					3,250
MF600 6.10	96051					3,250
MF600 6.20	96061					3,250
MF600 6.30	96071	101	28	65	6.0→6.3	3,250
MF600 6.40	96081					3,250
MF600 6.50	96091					3,250
MF600 6.60	96101					3,250
MF600 6.70	96111					3,250
MF600 6.80	96121					3,740
MF600 6.90	96131					3,740
MF600 7.00	96141					3,740
MF600 7.10	96151	109	31	73	7.0→7.1	3,740
MF600 7.20	96161					3,740
MF600 7.30	96171					3,740
MF600 7.40	96181					3,740
MF600 7.50	96191					3,740
MF600 7.60	96201					3,850
MF600 7.70	96211					3,850
MF600 7.80	96221					3,850
MF600 7.90	96231					3,850
MF600 7.97	96238					3,850
MF600 7.98	96239					3,850
MF600 7.99	96240					3,850
MF600 8.00	96241	117	33	81	8.0	3,850
MF600 8.01	96242					3,850
MF600 8.02	96243					3,850
MF600 8.10	96251					3,850
MF600 8.20	96261					3,850
MF600 8.30	96271					3,850
MF600 8.40	96281					3,850
MF600 8.50	96291					3,850
MF600 8.60	96301					4,040
MF600 8.70	96311					4,040
MF600 8.80	96321					4,040
MF600 8.90	96331					4,040
MF600 9.00	96341					4,040
MF600 9.01	96342	125	36	85	9.0	4,040
MF600 9.02	96343					4,040
MF600 9.10	96351					4,040
MF600 9.20	96361					4,040
MF600 9.30	96371					4,040
MF600 9.40	96381					4,040
MF600 9.50	96391	125→133			9.0→10.0	4,040
MF600 9.56	96397					4,730
MF600 9.60	96401					4,730
MF600 9.70	96411					4,730
MF600 9.80	96421	133	38	93	10.0	4,730
MF600 9.90	96431					4,730
MF600 9.97	96438					4,730
MF600 9.98	96439					4,730
MF600 9.99	96440					4,730

※ 在庫なくなり次第、取寄せ品となります。
 ※ 取寄せ品においては一部寸法が変更になっています。(表中の“→”が変更寸法です)
 メーカー切り替え中の為、寸法については弊社窓口までお問い合わせください。

マシンリーマ

マシンリーマ

各サイズ最大0~+0.005公差で各種穴仕上げ寸法に対応!

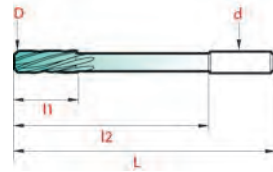

HSS Co ネジレ角 左10° 食付角 45°

公差	D	d	l ₁	L	刃数	
					Z	φ
0.60~3.00	0,+0.003	h8	+1	±1	4	0.60~1.05
3.01~6.00	0,+0.004	h8	+1	±1	6	1.06~12.50
6.01~202	0,+0.005	h8	+1	±1	8	12.51~202

MF600

型番	WEBコード	L	φ1(min)	φ2	d	価格
MF600 10.00	96441	133	38	93	10.0	4,730
MF600 10.01	96442					4,730
MF600 10.02	96443					4,730
MF600 10.10	96451					4,730
MF600 10.20	96461					4,730
MF600 10.30	96471					4,730
MF600 10.40	96481					4,730
MF600 10.50	96491					4,730
MF600 10.60	96501					4,730
MF600 10.70	96511					4,730
MF600 10.80	96521	133→142	41	102	12.0→10.0	4,730
MF600 10.90	96531					4,730
MF600 11.00	96541					4,730
MF600 11.10	96551					4,730
MF600 11.20	96561					4,730
MF600 11.30	96571					4,730
MF600 11.40	96581					6,330
MF600 11.50	96591					6,330
MF600 11.60	96601					6,330
MF600 11.70	96611					6,330

MF600

型番	WEBコード	L	φ1(min)	φ2	d	価格
MF600 11.80	96621	151→142	41	102	12.0→10.0	6,330
MF600 11.90	96631					6,330
MF600 11.97	96638					6,330
MF600 11.98	96639					6,330
MF600 11.99	96640					6,330
MF600 12.00	96641					6,330
MF600 12.09	96650					6,330
MF600 12.10	96651					6,330
MF600 12.20	96661					6,330
MF600 12.30	96671					6,330
MF600 12.40	96681	151	44	111	14.0→12.5	6,330
MF600 12.50	96691					6,330
MF600 12.60	96701					6,330
MF600 12.70	96711					6,330
MF600 12.80	96721					6,330
MF600 12.90	96731					6,330
MF600 13.00	96741					7,020
MF600 14.00	96765					7,800
MF600 15.00	96776					9,990
MF600 16.00	96787					10,230
MF600 17.00	96798	170	52	125	16.0→14.0	12,630
MF600 18.00	96807					12,630
MF600 19.00	96818					12,630
MF600 20.00	96827					12,830

※ 在庫なくなり次第、取寄せ品となります。
 ※ 取寄せ品においては一部寸法が変更になっています。
 (表中の“→”が変更寸法です)
 メーカー切り替え中の為、寸法については弊社窓口までお問い合わせください。

90°防振3枚刃Red'Xコート

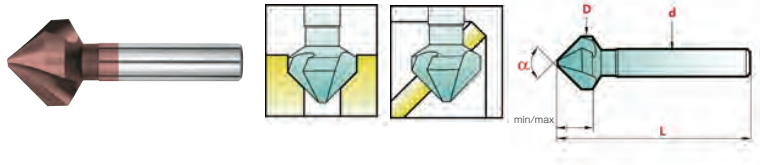

公差

D	Angle	d	L
z9	0 $-1'$	h9	± 1

MF493A

型番	WEBコード	α	min / max	D	L	d	価格		
MF493A 4.3	333474	90°	1.3 / 4.3	4.3	40	4	2,350		
MF493A 5.3	333475		1.5 / 5.3	5.3			2,350		
MF493A 6.0	333476		1.5 / 6.0	6.0			45	5	2,350
MF493A 6.3	333477		1.5 / 6.3	6.3					2,350
MF493A 8.0	333478		2.0 / 8.0	8.0	50	6			2,830
MF493A 8.3	333479		2.0 / 8.3	8.3					2,830
MF493A 9.4	333480		2.2 / 9.4	9.4			3,060		
MF493A 10.0	333481		2.5 / 10.0	10.0			3,060		
MF493A 10.4	333482		2.5 / 10.4	10.4	56	8	3,060		
MF493A 11.5	333483		2.8 / 11.5	11.5			3,540		
MF493A 12.0	333484		2.8 / 12.0	12.0			3,540		
MF493A 12.4	333485		2.8 / 12.4	12.4			3,540		
MF493A 15.0	333486		3.2 / 15.0	15.0	60	10	4,400		
MF493A 16.5	333487		3.2 / 16.5	16.5			4,400		
MF493A 20.5	333488		3.5 / 20.5	20.5			63	10	4,940
MF493A 25.0	333489		3.8 / 25.0	25.0					7,850
MF493A 28.0	333490		4.0 / 28.0	28.0	67	12	8,340		
MF493A 30.0	333491		4.2 / 30.0	30.0			9,330		
MF493A 31.0	333492		4.2 / 31.0	31.0			71	9,330	

MF493A 6本セット

型番	WEBコード	セット内容	価格
MF493A 6pcs pack	334405	MF493A 6.3	21,120
		MF493A 8.3	
		MF493A 10.4	
		MF493A 12.4	
		MF493A 16.5	
		MF493A 20.5	

カウンターシンク

90°3枚刃Red'Xコート

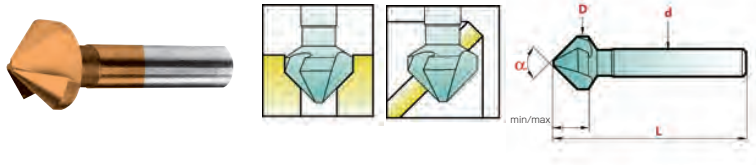

公差

D	Angle	d	L
4.0~31.0	±9	0	
34.0~80.0	0,+0.3	-1'	h9 ±1

MF4731/4737(MF4931/4937) ※1

型番	WEBコード	α	min / max	D	L	d	価格		
MF4731 4.0	76505	90°	1.3 / 4.0	4.0	40	4	1,810		
MF4731 4.3	76506		1.3 / 4.3	4.3			1,810		
MF4731 5.0	76507		1.5 / 5.0	5.0			1,810		
MF4731 5.3	76508		1.5 / 5.3	5.3			1,810		
MF4731 5.8-5	MA070		1.5 / 5.8	5.8			45	5	1,810
MF4731 5.8-6	76509							6	1,810
MF4731 6.0-5	MA071				5	1,810			
MF4731 6.0-6	76510		1.5 / 6.0	6.0	50	6	1,810		
MF4731 6.3-5	MA076					5	1,810		
MF4731 6.3-6	76511					5	1,810		
MF4731 7.0	76512		1.8 / 7.0	7.0	56	6	2,170		
MF4731 7.3	76513		1.8 / 7.3	7.3			2,170		
MF4731 8.0	76514		2.0 / 8.0	8.0			2,170		
MF4731 8.3	76515		2.0 / 8.3	8.3			2,170		
MF4731 9.4	76516		2.2 / 9.4	9.4			2,350		
MF4731 10.0	76517		2.5 / 10.0	10.0			2,350		
MF4731 10.4	76518		2.5 / 10.4	10.4	60	8	2,350		
MF4731 11.5	76519		2.8 / 11.5	11.5			2,720		
MF4731 12.0	76520		2.8 / 12.0	12.0			2,720		
MF4731 12.4	76521		2.8 / 12.4	12.4			2,720		
MF4731 13.4	76522		2.9 / 13.4	13.4			63	10	3,380
MF4731 14.4	76523		2.9 / 14.4	14.4					3,380
MF4731 15.0	76524		3.2 / 15.0	15.0	3,380				
MF4731 16.5-8	76525		3.2 / 16.5	16.5	56	8	3,380		
MF4731 16.5-10	MA077				60	3,380			
MF4731 19.0	76526				3.5 / 19.0	19.0	67	12	3,800
MF4731 20.5	76527		3.5 / 20.5	20.5	3,800				
MF4731 23.0	76528		3.8 / 23.0	23.0	71	16			5,380
MF4731 25.0	76529		3.8 / 25.0	25.0			6,040		
MF4731 26.0	76530		3.8 / 26.0	26.0			6,040		
MF4731 28.0	76531		4.0 / 28.0	28.0	103	16	6,410		
MF4731 30.0	76532		4.2 / 30.0	30.0			7,170		
MF4731 31.0	76533		4.2 / 31.0	31.0			7,170		
MF4737 35.0※2	76534	4.5 / 35.0	35.0	103	118	16	9,790		
MF4737 40.0※2	76535	4.5 / 40.0	40.0	118			13,090		
MF4737 50.0※2	76536	5.0 / 50.0	50.0	126			17,140		
MF4737 63.0※2	76537	10.0 / 63.0	63.0	140			34,800		
MF4737 80.0※2	76538	14.0 / 80.0	80.0	166			64,410		

※2 シャンク部 3ヶ所にフラット面を設けております。

MF4731 5本セット ※1

型番	WEBコード	セット内容	価格
MF4731 5pcs pack	MAG05	MF4731 6.3-5	17,380
		MF4731 10.4	
		MF4731 16.5-10	
		MF4731 20.5	
		MF4731 25.0	

MF4731 6本セット ※1

型番	WEBコード	セット内容	価格
MF4731 6pcs pack	MAG06	MF4731 6.3-5	16,230
		MF4731 8.3	
		MF4731 10.4	
		MF4731 12.4	
		MF4731 16.5-10	
		MF4731 20.5	

※1 MF4731/4737 が無くなり次第、MF4931/4937 に型番移行致します。

90°3枚刃



公差

D	Angle	d	L
4.0~31.0	z9	0	
35.0~50.0	0,+0.3	-1'	h9 ±1

MF431/437

型番	WEBコード	α	min / max	D	L	d	価格		
MF431 4.3	01218	90°	1.3 / 4.3	4.3	40	4	1,310		
MF431 5.0	01219		1.5 / 5.0	5.0			1,310		
MF431 5.3	01220		1.5 / 5.3	5.3			1,310		
MF431 5.8-5	MA072		1.5 / 5.8	5.8			5	1,310	
MF431 5.8-6	01221							6	1,310
MF431 6.0-5	MA073		1.5 / 6.0	6.0			45	5	1,310
MF431 6.0-6	01222				6	1,310			
MF431 6.3-5	MA074		1.5 / 6.3	6.3	5	1,310			
MF431 6.3-6	01223					1,310			
MF431 7.0	01224		1.8 / 7.0	7.0	50	6	1,480		
MF431 7.3	01225		1.8 / 7.3	7.3			1,480		
MF431 8.0	01226		2.0 / 8.0	8.0			1,480		
MF431 8.3	01227		2.0 / 8.3	8.3			1,480		
MF431 9.0	01228		2.2 / 9.0	9.0			1,630		
MF431 9.4	01229		2.2 / 9.4	9.4			1,630		
MF431 10.0	01230		2.5 / 10.0	10.0			1,630		
MF431 10.4	01231		2.5 / 10.4	10.4			1,630		
MF431 11.5	01232		2.8 / 11.5	11.5			56	8	1,910
MF431 12.0	01233		2.8 / 12.0	12.0					1,910
MF431 12.4	01234		2.8 / 12.4	12.4	1,910				
MF431 14.4	01235		2.9 / 14.4	14.4	2,460				
MF431 15.0	01236		3.2 / 15.0	15.0	60	10	2,460		
MF431 16.5-8	01237		3.2 / 16.5	16.5	56	8	2,460		
MF431 16.5-10	MA075				60	2,460			
MF431 19.0	01238		3.5 / 19.0	19.0	63	10	2,720		
MF431 20.5	01239		3.5 / 20.5	20.5	2,720				
MF431 23.0	01240		3.8 / 23.0	23.0	67	10	4,090		
MF431 25.0	01241		3.8 / 25.0	25.0			4,090		
MF431 26.0	01242		3.8 / 26.0	26.0	71	12	4,620		
MF431 28.0	01243		4.0 / 28.0	28.0			4,620		
MF431 30.0	01244		4.2 / 30.0	30.0	103	16	5,440		
MF431 31.0	01245	4.2 / 31.0	31.0	5,440					
MF437 35.0*	01246	4.5 / 35.0	35.0	118	16	7,880			
MF437 40.0*	01247	4.5 / 40.0	40.0	10,860					
MF437 50.0*	01248	5.0 / 50.0	50.0	126		14,660			

※ シャンク部 3ヶ所にフラット面を設けております。

カウンターシンク

90°3枚刃Hard'Xコート

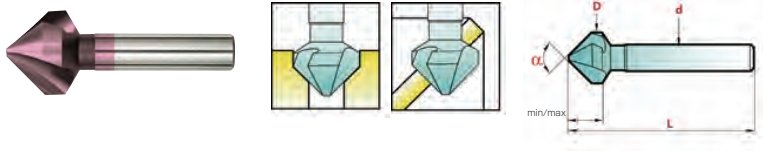

公差

D	Angles	d	L
z9	0 -1°	h9	±1

MF8431-H

型番	WEBコード	α	min / max	D	L	d	価格
MF8431-H 4.3	49477	90°	1.3 / 4.3	4.3	40	4	7,870
MF8431-H 5.3	49478		1.5 / 5.3	5.3			
MF8431-H 6.3	49479		1.5 / 6.3	6.3	45	5	8,970
MF8431-H 8.3	49480		2.0 / 8.3	8.3			
MF8431-H 10.4	49481		2.5 / 10.4	10.4	50	6	10,610
MF8431-H 12.4*	49482		2.8 / 12.4	12.4			
MF8431-H 16.5*	49483		3.2 / 16.5	16.5	60	8	14,300
MF8431-H 20.5*	49484		3.5 / 20.5	20.5			
MF8431-H 25.0*	49485		3.8 / 25.0	25.0	67	10	20,240
MF8431-H 31.0*	49486		4.2 / 31.0	31.0			

※ シャンク部3ヶ所にフラット面を設けております。

60°3枚刃

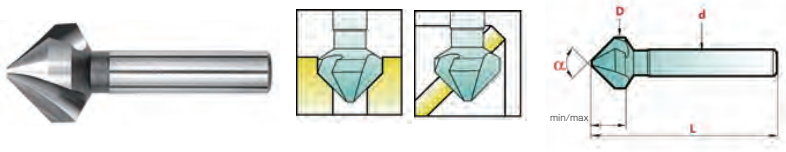

公差

D	Angle	d	L
z9	0 -1°	h9	±1

MF432

型番	WEBコード	α	min / max	D	L	d	価格
MF432 6.3	01262	60°	1.5 / 6.3	6.3	47	5	1,840
MF432 8.3	01263		2.0 / 8.3	8.3			
MF432 10.4	01264		2.5 / 10.4	10.4	53	6	1,700
MF432 12.4	01265		2.8 / 12.4	12.4			
MF432 16.5	01266		3.2 / 16.5	16.5	60	8	2,200
MF432 20.5	01267		3.5 / 20.5	20.5			
MF432 25.0	01268		3.8 / 25.0	25.0	69	10	2,810
MF432 31.0	01269		4.2 / 31.0	31.0			

90°1枚刃Red'Xコート

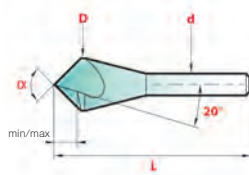
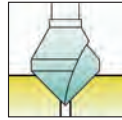

公差

D	Angle	d	L
+0.3 0	0 -1'	h9	±1

MF4721

型番	WEBコード	α	min / max	D	L	d	価格
MF4721 6.0	49469	90°	1 / 6	6.0	40	6	1,970
MF4721 8.0	49470		1 / 8	8.0			2,280
MF4721 10.0	49471		1 / 10	10.0	45	2,410	
MF4721 12.0	49472		2 / 12	12.0	50	2,700	
MF4721 15.0	49473		2 / 15	15.0	55	3,000	
MF4721 20.0	49474		2 / 20	20.0	65	10	4,100
MF4721 25.0	49475		3 / 25	25.0	78	12	7,470
MF4721 30.0	49476		3 / 30	30.0	88	12	7,860

1枚刃シングルタイプ

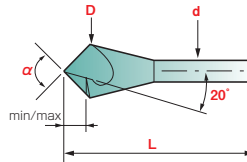
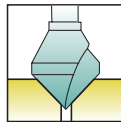

公差

D	Angle	d	L
+0.3 0	0 -1'	h9	±1

MF421 (90°)

型番	WEBコード	α	min / max	D	L	d	価格
MF421 4.0	01202	90°	1 / 4	4.0	40	4	1,040
MF421 5.0	01203		1 / 5	5.0		5	1,100
MF421 6.0	01204		1 / 6	6.0		6	1,160
MF421 8.0	01205		1 / 8	8.0		6	1,200
MF421 10.0	01206		1 / 10	10.0	45	6	1,260
MF421 12.0	01207		2 / 12	12.0	50	8	1,520
MF421 15.0	01208		2 / 15	15.0	55	8	1,630
MF421 20.0	01209		2 / 20	20.0	65	10	2,460
MF421 25.0	01210		3 / 25	25.0	78	12	4,090
MF421 30.0	01211		3 / 30	30.0	88	12	5,000
MF421 35.0*	01212		4 / 35	35.0	103	16	7,880
MF421 40.0*	01213		5 / 40	40.0	118	16	10,860
MF421 50.0*	01214		12 / 50	50.0	126	16	14,660

*シャンク部3ヶ所にフラット面を設けております。

MF422 (60°)

型番	WEBコード	α	min / max	D	L	d	価格
MF422 6.0	01194	60°	1 / 6	6.0	43	6	1,310
MF422 10.0	01195		1 / 10	10.0	49		1,450
MF422 12.0	01196		2 / 12	12.0	54	8	1,760
MF422 15.0	01197		2 / 15	15.0	60	8	1,890
MF422 20.0	01198		2 / 20	20.0	72	10	2,810
MF422 25.0	01199		3 / 25	25.0	78	10	4,690
MF422 30.0	01200		3 / 30	30.0	99	12	6,250

カウンターシンク

90°ホールタイプTiNコート

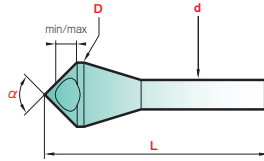
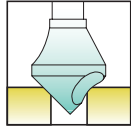

公差

D	Angle	d	L
+0.3 0	0 -1'	h9	±1

MF4811 (TiNコート)

型番	WEBコード	α	min / max	D	L	d	価格
MF4811 10.0	01179	90°	4 / 9	10.0	45	6	1,960
MF4811 15.0-6	01180		6 / 14	15.0	48	8	2,560
MF4811 15.0-8	29184		55	10	3,300		
MF4811 20.0	01181		8 / 18	20.0	65	10	3,540
MF4811 25.0	01182		10 / 23	25.0	78	12	5,380
MF4811 28.0	01183		11 / 26	28.0	87	12	10,190
MF4811 30.0	01184		12 / 28	30.0	106	16	7,170
MF4811 35.0*	01185		14 / 33	35.0	106	16	9,770

※シャンク部 3ヶ所にフラット面を設けております。

ホールタイプ

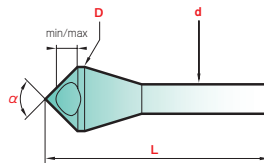
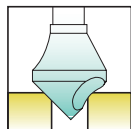

公差

D	Angle	d	L
+0.3 0	0 -1'	h9	±1

MF411 (90°)

型番	WEBコード	α	min / max	D	L	d	価格
MF411 10.0	01171	90°	4 / 9	10.0	45	6	1,260
MF411 15.0-6	01172		6 / 14	15.0	48	8	1,630
MF411 15.0-8	01353		55	10	1,630		
MF411 20.0	01173		8 / 18	20.0	65	10	2,460
MF411 25.0	01174		10 / 23	25.0	78	12	4,090
MF411 28.0	01175		11 / 26	28.0	87	12	5,000
MF411 30.0	01176		12 / 28	30.0	106	16	5,440
MF411 35.0*	01177		14 / 33	35.0	106	16	7,880

※シャンク部 3ヶ所にフラット面を設けております。

MF412 (60°)

型番	WEBコード	α	min / max	D	L	d	価格
MF412 10.0	01187	60°	5 / 9	10.0	49	6	1,450
MF412 15.0	01188		8 / 14	15.0	60	8	1,890
MF412 20.0	01189		10 / 18	20.0	71	10	2,810
MF412 25.0	01190		12 / 23	25.0	85	12	4,690
MF412 30.0	01191		15 / 28	30.0	96	12	6,250
MF412 35.0*	01192		17 / 33	35.0	117	16	9,070

※シャンク部 3ヶ所にフラット面を設けております。

90°ダブルアングルポイントドリル

DUO=MAG

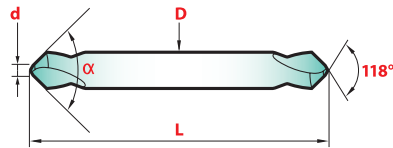

公差

D	d	L	Angles
h7	±0.05	±1	±1°

MF019(レギュラ)

型番	WEBコード	α	D	d	L	価格
MF019 3.0X0.5 90°	49401	90°	3.0	0.5	40	1,160
MF019 4.0X1.0 90°	49402		4.0	1	45	1,080
MF019 6.0X2.0 90°	49403		6.0	2	55	1,020
MF019 8.0X2.5 90°	49404		8.0	2.5	65	1,230
MF019 10.0X3.0 90°	49405		10.0	3	75	1,800
MF019 12.0X3.5 90°	49406		12.0	3.5	85	2,370
MF019 16.0X4.0 90°	49407		16.0	4	90	4,060
MF019 20.0X5.0 90°	49408		20.0	5	100	5,970

MF019L(ロング)

型番	WEBコード	α	D	d	L	価格
MF019L 3.0X0.5 90°	49431	90°	3.0	0.5	100	1,600
MF019L 4.0X1.0 90°	49432		4.0	1		1,740
MF019L 6.0X2.0 90°	49433		6.0	2		2,140
MF019L 8.0X2.5 90°	49434		8.0	2.5		2,330
MF019L 10.0X3.0 90°	49435		10.0	3		2,750
MF019L 12.0X3.5 90°	49436		12.0	3.5		3,340

MF019XL(エキストラロング)

型番	WEBコード	α	D	d	L	価格
MF019XL 8.0X2.5 90°	49454	90°	8.0	2.5	150	3,070
MF019XL 10.0X3.0 90°	49455		10.0	3		3,600
MF019XL 12.0X3.5 90°	49456		12.0	3.5		4,260
MF019XL 16.0X4.0 90°	49457		16.0	4		5,580
MF019XL 20.0X5.0 90°	49458		20.0	5		7,580

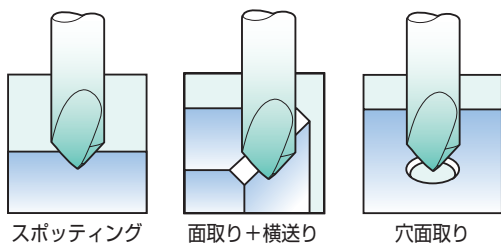

DUO=MAG

デュオマグ先端形状
ダブルアングルにすることで
チッピングの発生を抑制します。

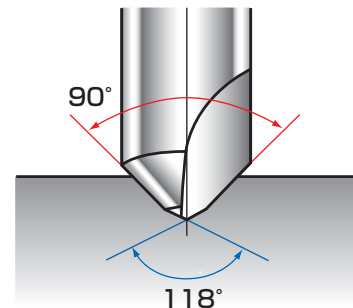



NC スポットニングドリル

90°ダブルアングルポイントドリル

DUO=MAG

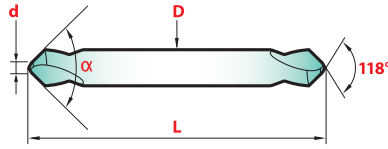

公差

D	d	L	Angles
h7	±0.05	±1	±1°

MF0919(レギュラ)

型番	WEBコード	α	D	d	L	価格
MF0919 3.0X0.5 90°	49417	90°	3.0	0.5	40	2,090
MF0919 4.0X1.0 90°	49418		4.0	1	45	1,930
MF0919 6.0X2.0 90°	49419		6.0	2	55	2,140
MF0919 8.0X2.5 90°	49420		8.0	2.5	65	2,690
MF0919 10.0X3.0 90°	49421		10.0	3	75	3,220
MF0919 12.0X3.5 90°	49422		12.0	3.5	85	3,850
MF0919 16.0X4.0 90°	49423		16.0	4	90	6,470
MF0919 20.0X5.0 90°	49424		20.0	5	100	10,090

MF0919L(ロング)

型番	WEBコード	α	D	d	L	価格
MF0919L 3.0X0.5 90°	49443	90°	3.0	0.5	100	3,080
MF0919L 4.0X1.0 90°	49444		4.0	1		3,350
MF0919L 6.0X2.0 90°	49445		6.0	2		4,170
MF0919L 8.0X2.5 90°	49446		8.0	2.5		4,580
MF0919L 10.0X3.0 90°	49447		10.0	3		5,390
MF0919L 12.0X3.5 90°	49448		12.0	3.5		6,510

MF0919XL(エキストラロング)

型番	WEBコード	α	D	d	L	価格
MF0919XL 8.0X2.5 90°	49464	90°	8.0	2.5	150	6,100
MF0919XL 10.0X3.0 90°	49465		10.0	3		7,020
MF0919XL 12.0X3.5 90°	49466		12.0	3.5		8,280
MF0919XL 16.0X4.0 90°	49467		16.0	4		10,760
MF0919XL 20.0X5.0 90°	49468		20.0	5		14,850

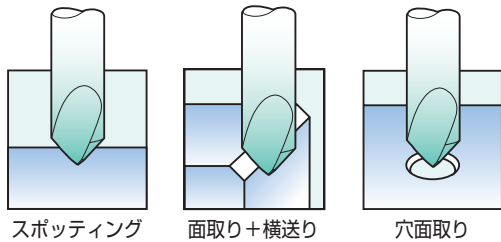

DUO=MAG

デュオマグ先端形状
ダブルアングルにすることで
チッピングの発生を抑制します。

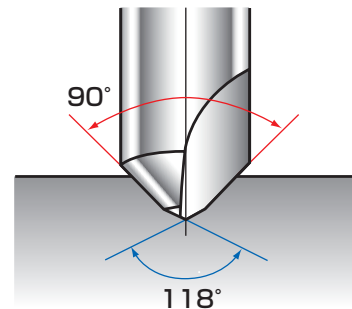

60°ダブルアングルポイントドリル

DUO=MAG

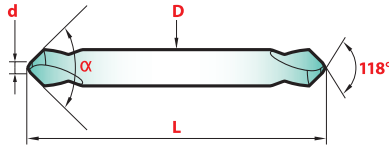

公差

D	d	L	Angles
h7	±0.05	±1	±1°

MF016(レギュラ)

型番	WEBコード	α	D	d	L	価格
MF016 3.0X0.5 60°	49393	60°	3.0	0.5	40	1,200
MF016 4.0X1.0 60°	49394		4.0	1	45	1,080
MF016 6.0X2.0 60°	49395		6.0	2	55	1,020
MF016 8.0X2.5 60°	49396		8.0	2.5	65	1,230
MF016 10.0X3.0 60°	49397		10.0	3	75	1,800
MF016 12.0X3.5 60°	49398		12.0	3.5	85	2,370
MF016 16.0X4.0 60°	49399		16.0	4	90	4,060
MF016 20.0X5.0 60°	49400		20.0	5	100	5,970

MF016L(ロング)

型番	WEBコード	α	D	d	L	価格
MF016L 3.0X0.5 60°	49425	60°	3.0	0.5	100	1,600
MF016L 4.0X1.0 60°	49426		4.0	1		1,740
MF016L 6.0X2.0 60°	49427		6.0	2		2,140
MF016L 8.0X2.5 60°	49428		8.0	2.5		2,330
MF016L 10.0X3.0 60°	49429		10.0	3		2,750
MF016L 12.0X3.5 60°	49430		12.0	3.5		3,340

MF016XL(エキストラロング)

型番	WEBコード	α	D	d	L	価格
MF016XL 8.0X2.5 60°	49449	60°	8.0	2.5	150	3,070
MF016XL 10.0X3.0 60°	49450		10.0	3		3,600
MF016XL 12.0X3.5 60°	49451		12.0	3.5		4,260
MF016XL 16.0X4.0 60°	49452		16.0	4		5,580
MF016XL 20.0X5.0 60°	49453		20.0	5		7,580

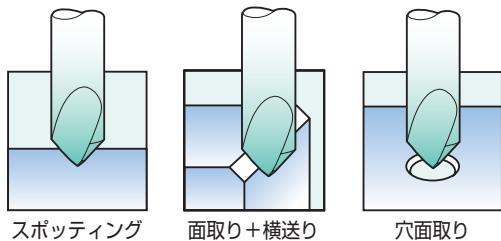

DUO=MAG

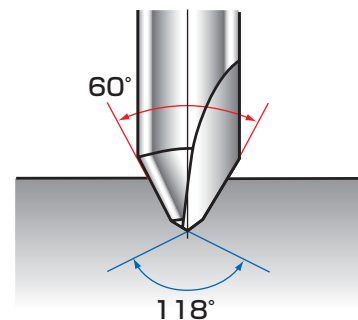
 デュオマグ先端形状
 ダブルアングルにすることで
 チッピングの発生を抑制します。

NC スポットニングドリル

60°ダブルアングルポイントドリル

DUO=MAG

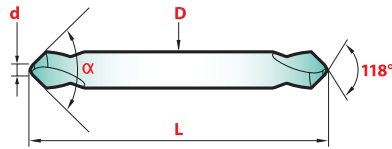

公差

D	d	L	Angles
h7	±0.05	±1	±1°

MF0916 (レギュラ)

型番	WEBコード	α	D	d	L	価格
MF0916 3.0X0.5 60°	49409	60°	3.0	0.5	40	2,090
MF0916 4.0X1.0 60°	49410		4.0	1	45	1,930
MF0916 6.0X2.0 60°	49411		6.0	2	55	2,140
MF0916 8.0X2.5 60°	49412		8.0	2.5	65	2,690
MF0916 10.0X3.0 60°	49413		10.0	3	75	3,220
MF0916 12.0X3.5 60°	49414		12.0	3.5	85	3,850
MF0916 16.0X4.0 60°	49415		16.0	4	90	6,470
MF0916 20.0X5.0 60°	49416		20.0	5	100	10,090

MF0916L (ロング)

型番	WEBコード	α	D	d	L	価格
MF0916L 3.0X0.5 60°	49437	60°	3.0	0.5	100	3,080
MF0916L 4.0X1.0 60°	49438		4.0	1		3,350
MF0916L 6.0X2.0 60°	49439		6.0	2		4,170
MF0916L 8.0X2.5 60°	49440		8.0	2.5		4,580
MF0916L 10.0X3.0 60°	49441		10.0	3		5,390
MF0916L 12.0X3.5 60°	49442		12.0	3.5		6,510

MF0916XL (エキストラロング)

型番	WEBコード	α	D	d	L	価格
MF0916XL 8.0X2.5 60°	49459	60°	8.0	2.5	150	6,100
MF0916XL 10.0X3.0 60°	49460		10.0	3		7,020
MF0916XL 12.0X3.5 60°	49461		12.0	3.5		8,280
MF0916XL 16.0X4.0 60°	49462		16.0	4		10,760
MF0916XL 20.0X5.0 60°	49463		20.0	5		14,850

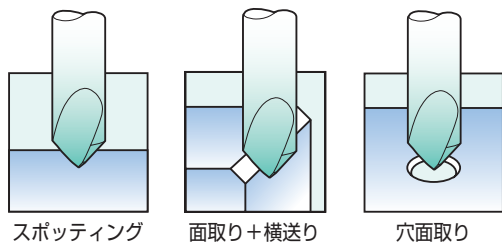

DUO=MAG

デュオマグ先端形状
ダブルアングルにすることで
チッピングの発生を抑制します。

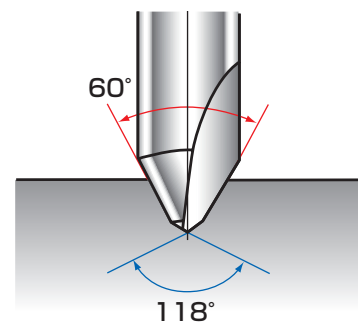

90°ダブルアングルポイントドリル

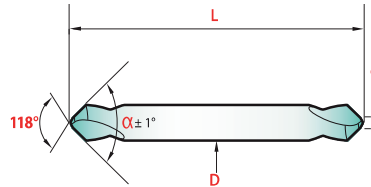

公差

D	d	L	Angles
h6	±0.05	±1	±1°

MF8119(ノンコート)

型番	WEBコード	α	D	d	L	価格
MF8119 3.0X0.5 90°	MA321	90°	3.0	0.5	40	4,720
MF8119 4.0X1.0 90°	MA322		4.0	1.0	45	4,980
MF8119 6.0X2.0 90°	MA323		6.0	2.0	55	6,050
MF8119 8.0X2.5 90°	MA324		8.0	2.5	65	8,620
MF8119 10.0X3.0 90°	MA325		10.0	3.0	75	11,200
MF8119 12.0X3.5 90°	MA326		12.0	3.5	85	16,000

MF8119-H(Hard'Xコート)

型番	WEBコード	α	D	d	L	価格
MF8119-H 3.0X0.5 90°	MA327	90°	3.0	0.5	40	5,430
MF8119-H 4.0X1.0 90°	MA328		4.0	1.0	45	5,690
MF8119-H 6.0X2.0 90°	MA329		6.0	2.0	55	6,850
MF8119-H 8.0X2.5 90°	MA330		8.0	2.5	65	9,510
MF8119-H 10.0X3.0 90°	MA331		10.0	3.0	75	12,180
MF8119-H 12.0X3.5 90°	MA332		12.0	3.5	85	17,240

90°マイクロNCスポットニングドリル

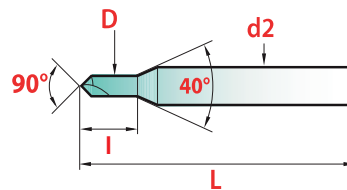
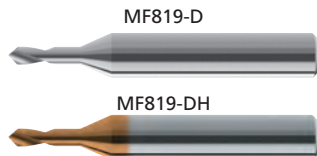

公差

D	Angle	L	l	d2
φ 0.3~0.5 +0.01	±1°	±1	+0.15	h5
φ 0.6~0.8 +0.01	±1°	±1	+0.20	h5
φ 0.9~2.5 +0.01	±1°	±1	+0.30	h5

MF819-D(ノンコート)

型番	WEBコード	α	D	d2	L	l	価格
MF819-D 0.3 90°	MA333	90°	0.3	3	39	0.9	5,100
MF819-D 0.4 90°	MA334		1.2			4,670	
MF819-D 0.5 90°	MA335		1.5			4,270	
MF819-D 0.6 90°	MA336		1.8			3,980	
MF819-D 0.7 90°	MA337		2.1			3,980	
MF819-D 0.8 90°	MA338		2.4			3,980	
MF819-D 0.9 90°	MA339		2.7			3,980	
MF819-D 1.0 90°	MA340		3.0			3,980	
MF819-D 1.2 90°	MA341		3.6			3,980	
MF819-D 1.5 90°	MA342		4.5			3,980	
MF819-D 2.0 90°	MA343		6.0			3,980	
MF819-D 2.5 90°	MA344		7.5			3,980	

MF819-DH(Hard'Xコート)

型番	WEBコード	α	D	d2	L	l	価格
MF819-DH 0.3 90°	MA345	90°	0.3	3	39	0.9	5,730
MF819-DH 0.4 90°	MA346		1.2			5,290	
MF819-DH 0.5 90°	MA347		1.5			4,760	
MF819-DH 0.6 90°	MA348		1.8			4,480	
MF819-DH 0.7 90°	MA349		2.1			4,480	
MF819-DH 0.8 90°	MA350		2.4			4,480	
MF819-DH 0.9 90°	MA351		2.7			4,480	
MF819-DH 1.0 90°	MA352		3.0			4,480	
MF819-DH 1.2 90°	MA353		3.6			4,480	
MF819-DH 1.5 90°	MA354		4.5			4,480	
MF819-DH 2.0 90°	MA355		6.0			4,480	
MF819-DH 2.5 90°	MA356		7.5			4,480	

NC スポットイングドリル

90°NCスポットイングドリル

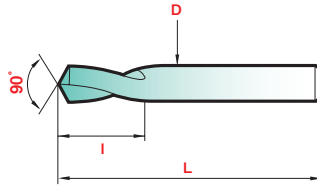

HSS Co **TiN** **90°**

MF0895
公差

D	Angle	L	I
h6	±1'	±1	+1 0

MF195 (ノンコート)

型番	WEBコード	D	l	L	価格
MF195 2.0	01113	2.0	8	49	1,050
MF195 3.0	01114	3.0	10	50	690
MF195 4.0	01115	4.0	12	52	790
MF195 5.0	01116	5.0	15	60	870
MF195 6.0	01117	6.0	20	66	940
MF195 8.0	01118	8.0	25	79	1,120
MF195 10.0	01119	10.0	35	89	1,780
MF195 12.0	01120	12.0	35	102	2,660
MF195 14.0	01121	14.0	35	115	3,100
MF195 16.0	01122	16.0	35	130	3,320
MF195 18.0	01123	18.0	40	130	4,140
MF195 20.0	01124	20.0	40	131	4,750
MF195 25.0	01125	25.0	45	138	7,000

MF0895 (TiNコート)

型番	WEBコード	D	l	L	価格
MF0895 2.0	01140	2.0	8	49	1,370
MF0895 3.0	01141	3.0	10	50	1,130
MF0895 4.0	01142	4.0	12	52	1,240
MF0895 5.0	01143	5.0	15	60	1,410
MF0895 6.0	01144	6.0	20	66	1,620
MF0895 8.0	01145	8.0	25	79	1,810
MF0895 10.0	01146	10.0	35	89	2,710
MF0895 12.0	01147	12.0	35	102	3,430
MF0895 14.0	01148	14.0	35	115	4,890
MF0895 16.0	01149	16.0	35	130	4,420
MF0895 18.0	01150	18.0	40	130	6,760
MF0895 20.0	01151	20.0	40	131	7,470
MF0895 25.0	01152	25.0	45	138	10,750

120°NCスポットイングドリル

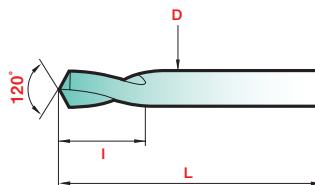
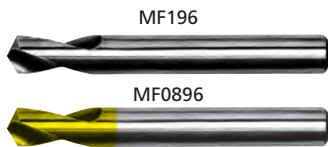

HSS Co **TiN** **120°**

MF0896
公差

D	Angle	L	I
h6	±1'	±1	+1 0

MF196 (ノンコート)

型番	WEBコード	D	l	L	価格
MF196 2.0	01127	2.0	8	49	1,050
MF196 3.0	01128	3.0	10	50	690
MF196 4.0	01129	4.0	12	52	790
MF196 5.0	01130	5.0	15	60	870
MF196 6.0	01131	6.0	20	66	940
MF196 8.0	01132	8.0	25	79	1,120
MF196 10.0	01133	10.0	35	89	1,780
MF196 12.0	01134	12.0	35	102	2,660
MF196 14.0	01135	14.0	35	115	3,100
MF196 16.0	01136	16.0	35	130	3,320
MF196 18.0	01137	18.0	40	130	4,140
MF196 20.0	01138	20.0	40	131	4,750
MF196 25.0	01139	25.0	45	138	7,000

MF0896 (TiNコート)

型番	WEBコード	D	l	L	価格
MF0896 4.0	01154	4.0	12	52	1,240
MF0896 6.0	01155	6.0	20	66	1,620
MF0896 8.0	01156	8.0	25	79	1,810
MF0896 10.0	01157	10.0	35	89	2,330
MF0896 12.0	01158	12.0	35	102	3,430
MF0896 16.0	01159	16.0	35	115	4,420
MF0896 18.0	01160	18.0	40	130	6,760
MF0896 20.0	01161	20.0	40	131	7,470
MF0896 25.0	01162	25.0	45	138	10,750

NC スポットティングドリル (ロング)

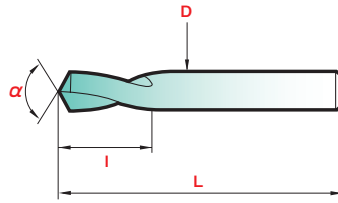

HSS Co 90° 120°

公差

D	Angle	L	l
h6	±1°	±1	+1 0

MF197 (90°)

型番	WEBコード	D	l	L	価格
MF197 4.0	01333	4.0	12	100	5,410
MF197 5.0	01334	5.0	15	120	5,680
MF197 6.0	01335	6.0	20	140	5,960
MF197 8.0	01336	8.0	25	170	6,650
MF197 10.0	01337	10.0	30	200	9,680
MF197 12.0	01338	12.0	35		10,250
MF197 16.0	01339	16.0	40		15,130
MF197 20.0	01340	20.0			19,590

MF199 (120°)

型番	WEBコード	D	l	L	価格
MF199 4.0	01163	4.0	12	100	5,410
MF199 5.0	01164	5.0	15	120	5,680
MF199 6.0	01165	6.0	20	140	5,960
MF199 8.0	01166	8.0	25	170	6,650
MF199 10.0	01167	10.0	30	200	9,680
MF199 12.0	01168	12.0	35		10,250
MF199 16.0	01169	16.0	40		15,130
MF199 20.0	01170	20.0			19,590

90°NC スポットティングドリル (超硬)

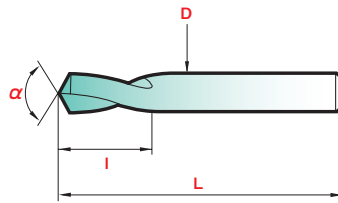
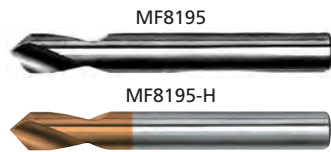

超硬 Hard'X 90°

MF8195-H

公差

D	Angle	L	l
h5	±1°	±1	+1 0

MF8195 (ノンコート)

型番	WEBコード	D	l	L	価格
MF8195 2.0	333421	2.0	8	40	3,530
MF8195 3.0	01315	3.0	10	45	4,100
MF8195 4.0	01316	4.0	12	50	4,410
MF8195 5.0	01317	5.0	15	60	4,720
MF8195 6.0	01318	6.0	18	70	4,950
MF8195 8.0	01319	8.0	23	80	7,010
MF8195 10.0	01320	10.0	24	100	10,040
MF8195 12.0	01321	12.0			14,540
MF8195 16.0	01322	16.0			24,260
MF8195 20.0	01323	20.0			43,740

MF8195-H (Hard'Xコート)

型番	WEBコード	D	l	L	価格
MF8195-H 2.0	333422	2.0	8	40	3,980
MF8195-H 3.0	333423	3.0	10	45	4,500
MF8195-H 4.0	333424	4.0	12	50	4,850
MF8195-H 5.0	333425	5.0	15	60	5,140
MF8195-H 6.0	333426	6.0	18	70	5,490
MF8195-H 8.0	333427	8.0	23	80	7,680
MF8195-H 10.0	333428	10.0	24	100	11,130
MF8195-H 12.0	333429	12.0			15,680
MF8195-H 16.0	333430	16.0			26,180
MF8195-H 20.0	333431	20.0			46,870

120°NC スポットティングドリル (超硬)

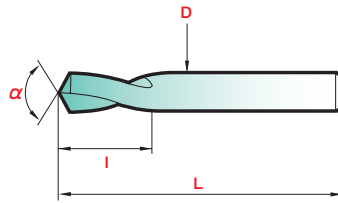
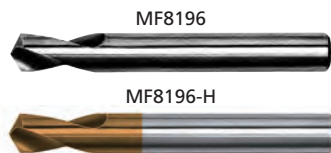

超硬 Hard'X 120°

MF8196-H

公差

D	Angle	L	l
h5	±1°	±1	+1 0

MF8196 (ノンコート)

型番	WEBコード	D	l	L	価格
MF8196 2.0	333454	2.0	8	40	3,530
MF8196 3.0	01324	3.0	10	45	4,100
MF8196 4.0	01325	4.0	12	50	4,410
MF8196 5.0	01326	5.0	15	60	4,720
MF8196 6.0	01327	6.0	18	70	4,950
MF8196 8.0	01328	8.0	23	80	7,010
MF8196 10.0	01329	10.0	24	100	10,040
MF8196 12.0	01330	12.0			14,540
MF8196 16.0	01331	16.0			24,260
MF8196 20.0	01332	20.0			43,740

MF8196-H (Hard'Xコート)

型番	WEBコード	D	l	L	価格
MF8196-H 2.0	333455	2.0	8	40	3,980
MF8196-H 3.0	333456	3.0	10	45	4,500
MF8196-H 4.0	333457	4.0	12	50	4,850
MF8196-H 5.0	333458	5.0	15	60	5,140
MF8196-H 6.0	333459	6.0	18	70	5,490
MF8196-H 8.0	333460	8.0	23	80	7,680
MF8196-H 10.0	333461	10.0	24	100	11,130
MF8196-H 12.0	333462	12.0			15,680
MF8196-H 16.0	333463	16.0			26,180
MF8196-H 20.0	333464	20.0			46,870

NC スポットティングドリル

90°NCスポットティングドリル(超硬ロング)

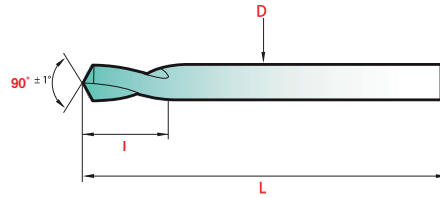
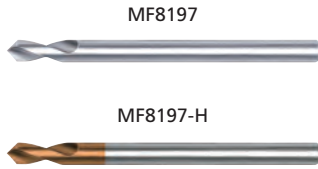

公差

D	Angle	L	I
h5	±1'	±1	+1

MF8197(ノンコート)

型番	WEBコード	D	l	L	価格
MF8197 1.0	333432	1.0	6	50	8,840
MF8197 2.0	333433	2.0	8	60	7,320
MF8197 3.0	333434	3.0	10	80	7,930
MF8197 4.0	333435	4.0	12	100	9,150
MF8197 5.0	333436	5.0	15	120	9,760
MF8197 6.0	333437	6.0	20	140	10,980
MF8197 8.0	333438	8.0	25	170	13,410
MF8197 10.0	333439	10.0	30	200	23,170
MF8197 12.0	333440	12.0	35	200	29,260
MF8197 16.0	333441	16.0	40	200	43,890
MF8197 20.0	333442	20.0	40	200	70,110

MF8197-H(Hard'Xコート)

型番	WEBコード	D	l	L	価格
MF8197-H 1.0	333443	1.0	6	50	9,210
MF8197-H 2.0	333444	2.0	8	60	7,680
MF8197-H 3.0	333445	3.0	10	80	8,290
MF8197-H 4.0	333446	4.0	12	100	9,510
MF8197-H 5.0	333447	5.0	15	120	10,120
MF8197-H 6.0	333448	6.0	20	140	11,460
MF8197-H 8.0	333449	8.0	25	170	13,900
MF8197-H 10.0	333450	10.0	30	200	23,780
MF8197-H 12.0	333451	12.0	35	200	30,180
MF8197-H 16.0	333452	16.0	40	200	45,110
MF8197-H 20.0	333453	20.0	40	200	71,630

142°NCスポットティングドリル(超硬)

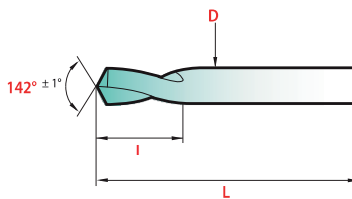

公差

D	Angles	L	I
h7	±1'	±1	+1

MF8190-H(Hard'Xコート)

型番	WEBコード	D	l	L	価格
MF8190-H 2.0	333465	2.0	8	40	3,420
MF8190-H 3.0	333466	3.0	10	45	3,110
MF8190-H 4.0	333467	4.0	12	50	3,600
MF8190-H 5.0	333468	5.0	15	50	4,090
MF8190-H 6.0	333469	6.0	18	60	4,510
MF8190-H 8.0	333470	8.0	23	60	6,340
MF8190-H 10.0	333471	10.0	24	70	9,150
MF8190-H 12.0	333472	12.0	26	80	12,800
MF8190-H 16.0	333473	16.0	26	80	21,220

60°ジャパスタンダード

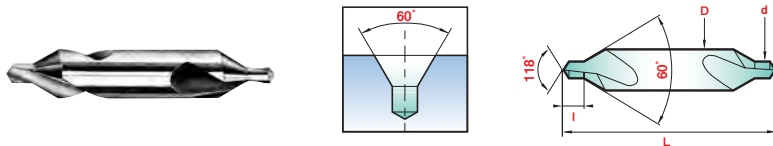

HSS

公差

D	d	L
h7	k12	±1

MF110(ノンコート)

型番	WEBコード	D	l	L	d	価格
MF110 3.0X0.3	01023	3.0	0.3~0.4	31	0.3	1,300
MF110 3.0X0.4	01024		0.5~0.7		0.4	1,120
MF110 3.5X0.5	01025	3.5	0.6~0.9	35	0.5	880
MF110 4.0X0.75	01026	4.0	1.0~1.3		0.75	700

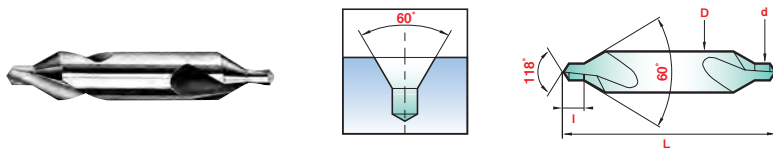

HSS Co

公差

D	d	L	Angles
1.0~1.5	±0.05		60° 118°
h7 2.0~4.0	±0.08	±1	-30° ±2°
5.0~6.0	±0.12		

MF118(ノンコート)

型番	WEBコード	D	l	L	d	価格
MF118 4.0X1.0	01341	4.0	1.2~1.5	35	1.0	540
MF118 5.0X1.2	01342		1.3~1.8	40	1.2	490
MF118 5.0X1.5	01343		1.5~2.0		1.5	430
MF118 6.0X2.0	01344	6.0	2.0~2.5	45	2.0	480
MF118 7.7X2.5	01345		2.5~3.0	50	2.5	580
MF118 7.7X3.0	01346	7.7	3.0~3.6	56	3.0	580
MF118 7.7X3.2	01347		3.2~3.8	57	3.2	740
MF118 10.0X4.0	01348	10.0	4.5~5.1	65	4.0	1,150
MF118 11.0X4.0	01349			69	4.0	1,320
MF118 11.0X5.0	01350	11.0	5.5~6.1		5.0	1,510
MF118 18.0X6.0	01351	18.0	7.0~8.0	95	6.0	3,550

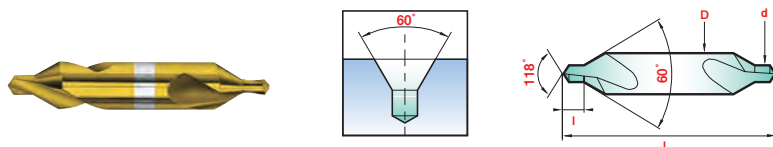

HSS Co TiN

公差

D	d	L	Angles
1.0~1.5	±0.05		60° 118°
h7 2.0~4.0	±0.08	±1	-30° ±2°
5.0~6.0	±0.12		

MF0818(TiNコート)

型番	WEBコード	D	l	L	d	価格
MF0818 4.0X1.0	333410	4.0	1.2~1.5	35	1.0	1,030
MF0818 5.0X1.2	333411		1.3~1.8	40	1.2	1,030
MF0818 5.0X1.5	333412		1.5~2.0		1.5	1,030
MF0818 6.0X2.0	333413	6.0	2.0~2.5	45	2.0	1,130
MF0818 7.7X2.5	333414		2.5~3.0	50	2.5	1,290
MF0818 7.7X3.0	333415	7.7	3.0~3.6	56	3.0	1,290
MF0818 7.7X3.2	333416		3.2~3.8	57	3.2	1,290
MF0818 10.0X4.0	333417	10.0	4.5~5.1	65	4.0	1,800
MF0818 11.0X4.0	333418			69	4.0	2,030
MF0818 11.0X5.0	333419	11.0	5.5~6.1		5.0	2,030
MF0818 18.0X6.0	333420	18.0	7.0~8.0	95	6.0	5,250

センタードリル

90°タイプ

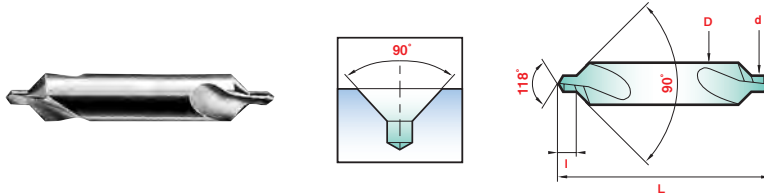

HSS

公差			
D	d	L	Angles
			90° 118°
h7	k12	±1	0 -30° ±2'

MF15

型番	WEBコード	D	l	L	d	価格
MF15 3.5X0.75	01076	3.5	1.0~1.3	35	0.75	1,360
MF15 4.0X1.0	01077	4.0	1.3~1.7		1.0	610
MF15 5.0X1.5	01078	5.0	2.0~2.6	40	1.5	580
MF15 6.0X2.0	01079	6.0	2.5~3.1		2.0	550
MF15 8.0X2.5	01080	8.0	3.1~3.8	50	2.5	660
MF15 8.0X3.0	01081		3.9~4.6		3.0	660
MF15 10.0X4.0	01082	10.0	5.0~5.9	55	4.0	1,340
MF15 12.0X5.0	01083	12.0	6.3~7.2	63	5.0	1,470
MF15 18.0X6.0	01084	18.0	8.0~8.9	77	6.0	4,840

60°ロングタイプ

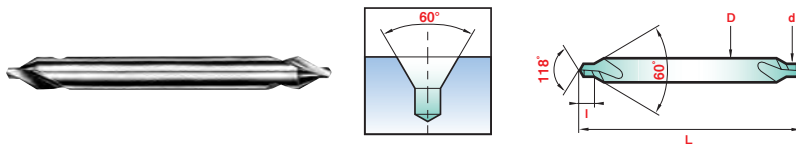

HSS Co

公差			
D	d	L	Angles
			60° 118°
h7	k12	±1	0 -30° ±2'

MF18

型番	WEBコード	D	l	L	d	価格
MF18 3.5X0.75X60	01086	3.5	1.0~1.3	60	0.75	1,190
MF18 4.0X1.0X60	01088	4.0	1.3~1.7		1.0	1,180
MF18 5.0X1.5X60	01093	5.0	2.0~2.6		1.5	1,150
MF18 6.0X2.0X80	01097	6.0	2.5~3.1		2.0	1,210
MF18 8.0X2.5X80	01101	8.0	3.1~3.8	80	2.5	1,480
MF18 8.0X3.0X80	01102		3.9~4.6		3.0	1,480
MF18 4.0X1.0X100	01089	4.0	1.3~1.7	100	1.0	1,780
MF18 5.0X1.5X100	01094	5.0	2.0~2.6		1.5	1,810
MF18 6.0X2.0X100	01098	6.0	2.5~3.1		2.0	1,670
MF18 8.0X2.5X100	01103	8.0	3.1~3.8		2.5	1,780
MF18 8.0X3.0X100	01104		3.9~4.6	3.0	2,070	
MF18 10.0X4.0X100	01109	10.0	5.0~5.9		4.0	1,890
MF18 3.5X0.75X120	01087	3.5	1.0~1.3	120	0.75	3,950
MF18 4.0X1.0X120	01090	4.0	1.3~1.7		1.0	2,820
MF18 5.0X1.5X120	01095	5.0	2.0~2.6		1.5	2,740
MF18 6.0X2.0X120	01099	6.0	2.5~3.1		2.0	2,710
MF18 8.0X2.5X120	01105	8.0	3.1~3.8	150	2.5	3,100
MF18 8.0X3.0X120	01106		3.9~4.6		3.0	3,100
MF18 10.0X4.0X120	01110	10.0	5.0~5.9		4.0	3,540
MF18 14.0X5.0X120	01111	14.0	6.3~7.2		5.0	5,120
MF18 4.0X1.0X150	01091	4.0	1.3~1.7	150	1.0	3,100
MF18 5.0X1.5X150	01096	5.0	2.0~2.6		1.5	2,490
MF18 6.0X2.0X150	01100	6.0	2.5~3.1		2.0	2,600
MF18 8.0X2.5X150	01107	8.0	3.1~3.8		2.5	3,100
MF18 8.0X3.0X150	01108		3.9~4.6	3.0	3,100	
MF18 10.0X4.0X150	01092	10.0	5.0~5.9		4.0	3,320

60° JIS I 型

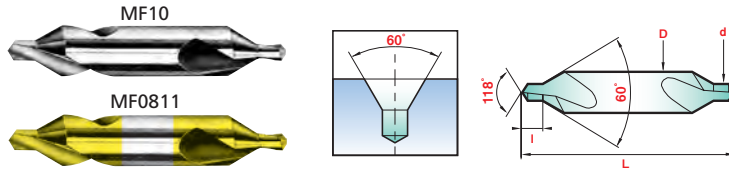

MF0811

公差

D	d	L	Angles	
			60°	118°
h7	k12	±1	0	±2°
			-30'	

MF10(ノンコート)

型番	WEBコード	D	l	L	d	価格
MF10 4.0X1.0	01002	4.0	1.3~1.7	35	1.0	940
MF10 5.0X1.5	01003	5.0	2.0~2.6	40	1.5	1,040
MF10 6.0X2.0	01004	6.0	2.5~3.1	45	2.0	1,170
MF10 8.0X2.5	01005	8.0	3.1~3.8	50	2.5	1,340
MF10 8.0X3.0	01006		3.9~4.6		3.0	1,340
MF10 10.0X4.0	01007	10.0	5.0~5.9	55	4.0	1,700
MF10 12.0X5.0	01008	12.0	6.3~7.2	63	5.0	2,740

MF0811(TiNコート)

型番	WEBコード	D	l	L	d	価格
MF0811 4.0X1.0	01009	4.0	1.3~1.7	35	1.0	1,340
MF0811 5.0X1.5	01010	5.0	2.0~2.6	40	1.5	1,460
MF0811 6.0X2.0	01011	6.0	2.5~3.1	45	2.0	1,580
MF0811 8.0X2.5	01012	8.0	3.1~3.8	50	2.5	1,830
MF0811 8.0X3.0	01013		3.9~4.6		3.0	1,830
MF0811 10.0X4.0	01014	10.0	5.0~5.9	55	4.0	2,360
MF0811 12.0X5.0	01015	12.0	6.3~7.2	63	5.0	3,930

先端補強型

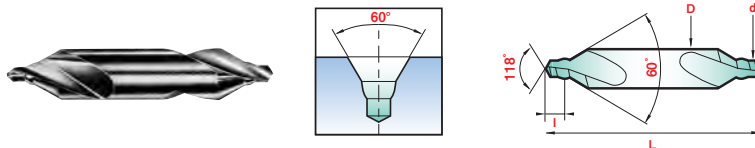

HSS

公差

D	d	L	Angles	
			60°	118°
h7	k12	±1	0	±2°
			-30'	

MF14

型番	WEBコード	D	l	L	d	価格
MF14 3.0X0.5	01041	3.0	0.6~0.9	31	0.5	1,400
MF14 4.0X1.0	01043	4.0	1.3~1.7	35	1.0	750
MF14 4.0X1.25	01044		1.6~2.0		1.25	750
MF14 5.0X1.5	01045	5.0	2.0~2.6	40	1.5	830
MF14 6.0X2.0	01046	6.0	2.5~3.1	45	2.0	910
MF14 8.0X2.5	01047	8.0	3.1~3.8	50	2.5	990
MF14 8.0X3.0	01048		3.9~4.6		3.0	990
MF14 10.0X4.0	01049	10.0	5.0~5.9	55	4.0	1,290
MF14 12.0X5.0	01050	12.0	6.3~7.2	63	5.0	2,180
MF14 18.0X6.0	01051	18.0	8.0~8.9	77	6.0	4,230
MF14 20.0X8.0	01052	20.0	10.1~11.1	80	8.0	6,510
MF14 25.0X10.0	01053	25.0	12.8~13.8	100	10.0	10,250

センタードリル

60°JIS型 超硬

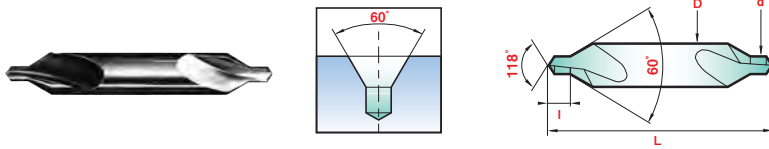

超硬

公差

D	d	L	Angles	
			60°	118°
h7	k12	±1	0	±2°
			-30'	

MF8100

型番	WEBコード	D	l	L	d	価格
MF8100 4.0X1.0	01016	4.0	1.3~1.7	35	1.0	3,910
MF8100 5.0X1.5	01017	5.0	2.0~2.6	40	1.5	4,870
MF8100 6.0X2.0	01018	6.0	2.5~3.1	45	2.0	6,070
MF8100 8.0X2.5	01019	8.0	3.1~3.8	50	2.5	7,500
MF8100 8.0X3.0	01020	8.0	3.9~4.6	50	3.0	7,500
MF8100 10.0X4.0	01021	10.0	5.0~5.9	55	4.0	12,240
MF8100 12.0X5.0	01022	12.0	6.3~7.2	63	5.0	15,690

タイプII

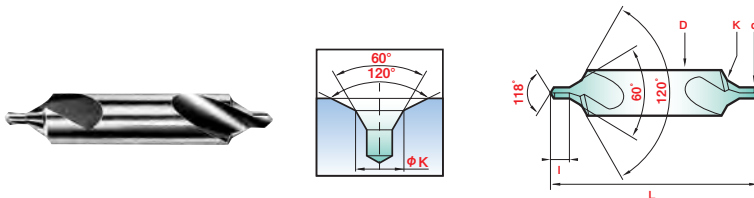

HSS

公差

D	d	L	K	Angles		
				60°	120°	118°
h7	k12	±1	js13	0	0	±2°
				-30'	-4'	

MF13

型番	WEBコード	D	K	l	L	d	価格
MF13 3.0X0.5	01067	3.0	1.2	0.6~0.9	31	0.5	1,410
MF13 4.0X1.0	01068	4.0	2.1	1.3~1.7	35	1.0	1,020
MF13 5.0X1.5	01069	5.0	3.0	2.0~2.6	40	1.5	1,120
MF13 6.0X2.0	01070	6.0	4.0	2.5~3.1	45	2.0	1,120
MF13 8.0X2.5	01071	8.0	5.5	3.1~3.8	50	2.5	1,410
MF13 10.0X3.0	01072	10.0	7.0	3.9~4.6	55	3.0	1,700
MF13 12.0X4.0	01073	12.0	9.0	5.0~5.9	63	4.0	2,350
MF13 14.0X5.0	01074	14.0	10.0	6.3~7.2	69	5.0	3,080
MF13 18.0X6.0	01075	18.0	12.0	8.0~8.9	77	6.0	4,230

両面取りカッタ

Bi-face

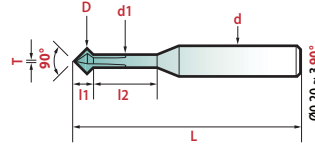
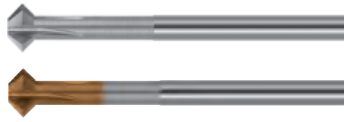

超硬 Hard'X
MF8480-H

公差

	D	α	d	L
1~5	0, -0.06	$\pm 1^\circ$	h6	± 1

MF8480(ノンコート)

型番	WEBコード	α	D	d1 max	T max	l1	l2 mini	L	d	刃数	価格
MF8480 0.2	333493	90°	0.2	0.12	0.12	0.11	0.29	39	3	1	9,800
MF8480 0.25	333494		0.25	0.15	0.15	0.13	0.37				9,520
MF8480 0.3	333495		0.30	0.18	0.18	0.15	0.45				9,520
MF8480 0.4	333496		0.40	0.24	0.24	0.19	0.61				9,240
MF8480 0.5	333497		0.50	0.30	0.30	0.23	0.77				8,960
MF8480 0.6	333498		0.60	0.36	0.36	0.27	0.93				8,680
MF8480 0.8	333499		0.80	0.48	0.48	0.35	1.25	60	3	3	8,400
MF8480 1.0	MA270		1.0	0.7	0.30	0.50	5				5,910
MF8480 1.5	MA271		1.5	1.1	0.45	0.73	6				5,750
MF8480 1.8	MA272		1.8	1.4	0.60	0.75	8				5,500
MF8480 2.0	MA273		2.0	1.5	0.90	0.95	10				5,500
MF8480 2.8	MA274		2.8	2.1	1.30	1.30	10				5,550
MF8480 3.0	MA275		3.0	3.0	1.50	1.50	10	5,550			

MF8480-H(Hard'Xコート)

型番	WEBコード	α	D	d1 max	T max	l1	l2 mini	L	d	刃数	価格
MF8480-H 0.2	333500	90°	0.2	0.12	0.12	0.11	0.29	39	3	1	10,360
MF8480-H 0.25	333501		0.25	0.15	0.15	0.13	0.37				10,080
MF8480-H 0.3	333502		0.30	0.18	0.18	0.15	0.45				10,080
MF8480-H 0.4	333503		0.40	0.24	0.24	0.19	0.61				9,800
MF8480-H 0.5	333504		0.50	0.30	0.30	0.23	0.77				9,520
MF8480-H 0.6	333505		0.60	0.36	0.36	0.27	0.93				9,240
MF8480-H 0.8	333506		0.80	0.48	0.48	0.35	1.25	60	3	3	8,960
MF8480-H 1.0	MA276		1.0	0.7	0.30	0.50	5				6,290
MF8480-H 1.5	MA277		1.5	1.1	0.45	0.73	6				6,010
MF8480-H 1.8	MA278		1.8	1.4	0.60	0.75	8				5,880
MF8480-H 2.0	MA279		2.0	1.5	0.90	0.95	10				5,880
MF8480-H 2.8	MA280		2.8	2.1	1.30	1.30	10				5,810
MF8480-H 3.0	MA281		3.0	3.0	1.50	1.50	10	5,810			

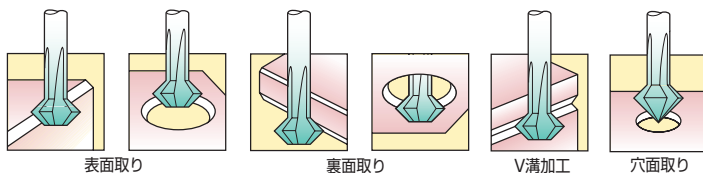

面取りカッタ

両面取りカッタ

Bi-face

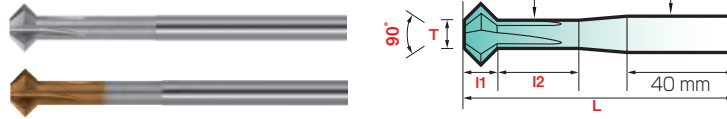

超硬 Hard'X

MF8490-H

公差

	D	α	d	L
1~5	0, -0.06 \pm 1'	h6	\pm 1	
6~16	0, -0.10 \pm 1'	h6	\pm 1	

MF8490 (ノンコート)

型番	WEBコード	α	D	d1 max	T max	l1	l2 mini	L	d	刃数	価格		
MF8490 2.8	MA282	90°	2.8	2.2	1.2	1.1	10	100	6	4	6,770		
MF8490 3.0	MA283		3.0			1.30					6,770		
MF8490 3.8	MA284		3.8	2.9	1.6	1.55	12				6,980		
MF8490 4.0	MA285		4.0			1.75					6,980		
MF8490 4.8	MA286		4.8	3.4	2.0	2.10	15				7,300		
MF8490 5.0	MA287		5.0			2.30					7,300		
MF8490 5.8	MA288		5.8	3.8	2.4	2.70	18				7,730		
MF8490 6.0	MA289		6.0			2.90					7,730		
MF8490 7.8	MA290		7.8	4.9	4.9	2.80	34				10	9,430	
MF8490 8.0	MA291		8.0			3.1						10,040	
MF8490 9.8	MA292		9.8	5.9	5.9	3.80						34	12,230
MF8490 10.0	MA293		10.0			4.1							12,230
MF8490 11.8	MA294		11.8	7.9	7.9	5.80						34	14,800
MF8490 12.0	MA295		12.0			6.1							14,800
MF8490 15.8	MA296		15.8	16.0	7.9	7.80						34	19,730
MF8490 16.0	MA297		16.0			8.1							19,730

MF8490-H (Hard'Xコート)

型番	WEBコード	α	D	d1 max	T max	l1	l2 mini	L	d	刃数	価格			
MF8490-H 2.8	MA298	90°	2.8	2.2	1.2	1.1	10	100	6	4	7,200			
MF8490-H 3.0	MA299		3.0			1.30					7,200			
MF8490-H 3.8	MA300		3.8	2.9	1.6	1.55	12				7,410			
MF8490-H 4.0	MA301		4.0			1.75					7,410			
MF8490-H 4.8	MA302		4.8	3.4	2.0	2.10	15				7,840			
MF8490-H 5.0	MA303		5.0			2.30					7,840			
MF8490-H 5.8	MA304		5.8	3.8	2.4	2.70	18				8,160			
MF8490-H 6.0	MA305		6.0			2.90					8,160			
MF8490-H 7.8	MA306		7.8	4.9	4.9	2.80	34				10	10,730		
MF8490-H 8.0	MA307		8.0			3.1						10,730		
MF8490-H 9.8	MA308		9.8	5.9	5.9	3.80						34	10	13,090
MF8490-H 10.0	MA309		10.0			4.1								13,090
MF8490-H 11.8	MA310		11.8	7.9	7.9	5.80						34	10	15,660
MF8490-H 12.0	MA311		12.0			6.1								15,660
MF8490-H 15.8	MA312		15.8	16.0	7.9	7.80						34	10	20,810
MF8490-H 16.0	MA313		16.0			8.1								20,810

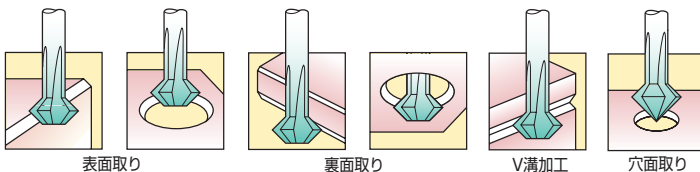

両面取りカッタ

Bi-face

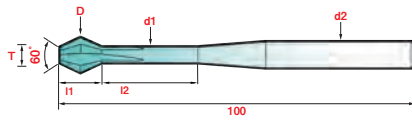
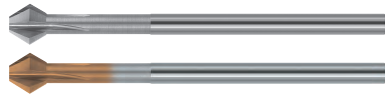

超硬 Hard'X

MF8460-H

公差

D	α	d	L
1~5	0, -0,05 \pm 1°	h6 \pm 1	
6~16	0, -0,10 \pm 1°	h6 \pm 1	

MF8460(ノンコート)

型番	WEBコード	α	D	d1 max	T max	l1	l2 mini	L	d	刃数	価格
MF8460 5.0	MA314	60°	5.0	3.4	3.4	2.8	15	100	6	4	9,400
MF8460 8.0	MA315		8.0	4.9	4.9	5.4	34				12,230
MF8460 12.0	MA316		12.0	5.9	5.9	10.6	18,020				

MF8460-H(Hard'Xコート)

型番	WEBコード	α	D	d1 max	T max	l1	l2 mini	L	d	刃数	価格
MF8460-H 5.0	MA317	60°	5.0	3.4	3.4	2.8	15	100	6	4	9,830
MF8460-H 8.0	MA318		8.0	4.9	4.9	5.4	34				12,870
MF8460-H 12.0	MA319		12.0	5.9	5.9	10.6	18,870				

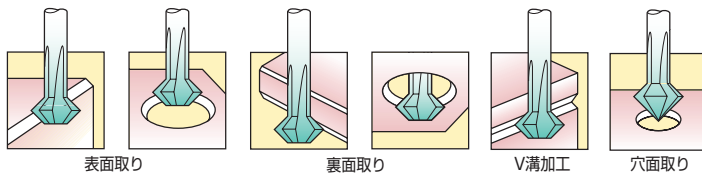

面取りカッタ

両面取りカッタ(ラジアス)

超硬 Hard'X

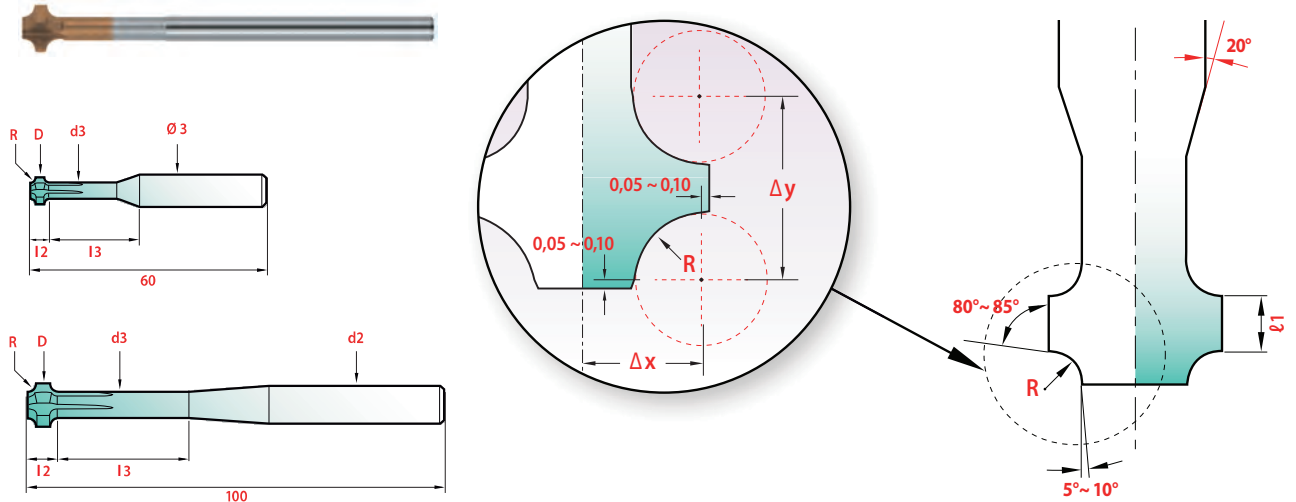

公差	
R	d2
±0.02	h5

MF848-RH (Hard'Xコート)/MF849-RH (Hard'Xコート)

型番	WEBコード	R	D	d3	d2	Δx	Δy	l1	l2	l3	刃数	価格
MF848-RH 0.2	333507	0.2	1.9	1.25	3	0.87	1.32	0.9	1.45	8	2	7,280
MF848-RH 0.3	333508	0.3	2.3	1.45		1.07	1.82	1.2	1.95	9		7,280
MF848-RH 0.4	333509	0.4	2.6	1.55		1.22	2.37	1.55	2.5	10		7,280
MF848-RH 0.5	333510	0.5	2.9	1.65	6	1.37	2.87	1.85	3	12	3	7,280
MF849-RH 0.5	333511		4.9	3.65		2.37	3.17	2.15	3.3	20		9,970
MF849-RH 0.6	333512	0.6	5.2	3.75	8	2.52	3.37	2.23	4.3	25	3	9,970
MF849-RH 0.8	333513	0.8	5.9	4.05		2.89	3.77		2.14	3.9		30
MF849-RH 1.0	333514	1.0	6.6	4.35	10	3.22	4.27	2.73	5.8	35	3	12,880
MF849-RH 1.2	333515	1.2	7.4	4.75		3.62	5.07		2.63			5.2
MF849-RH 1.5	333516	1.5	8.4	5.1	12	4.12	5.77	2.9	7.8	35	3	15,900
MF849-RH 1.8	333517	1.8	9.3	5.4		4.57	6.37		2.72			6.4
MF849-RH 2.0	333518	2.0	9.9	5.6	12	4.87	6.87	2.82	6.8	35	3	15,900
MF849-RH 2.5	333519	2.5	10.9			5.37	7.97		2.9			7.8
MF849-RH 3.0	333520	3.0	11.9			5.87	9.07	3.0	8.8			19,150

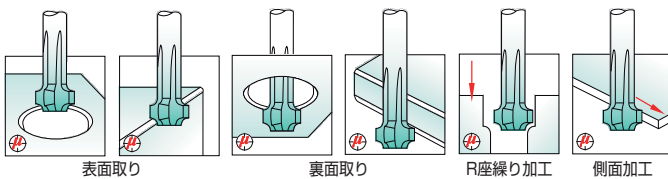

R面取りエンドミル

超硬 Hard'X

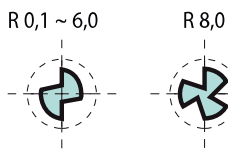
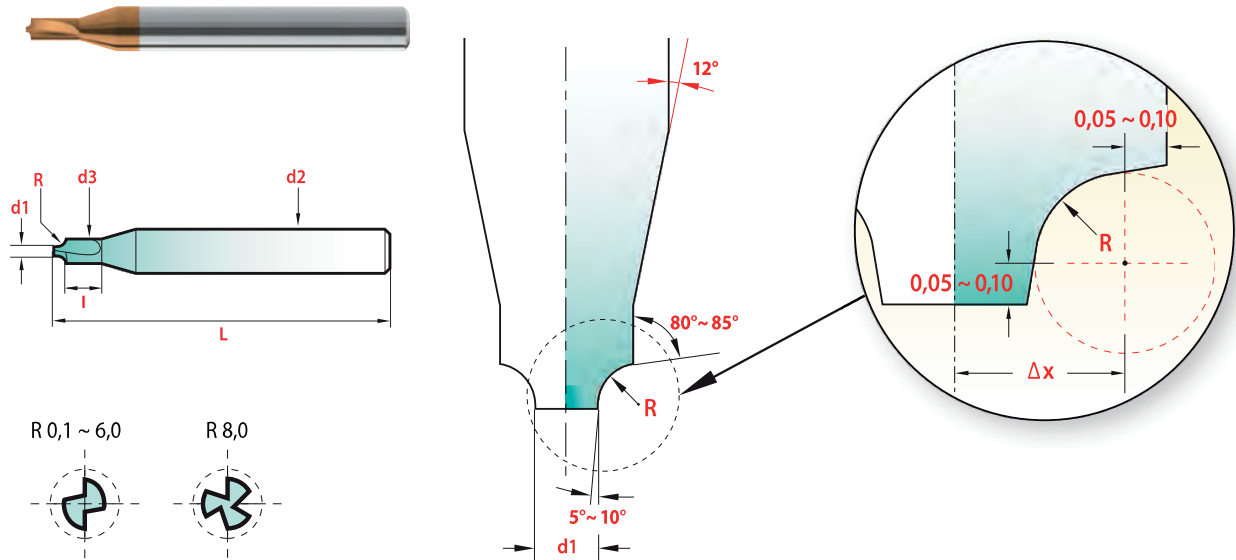

公差		
R	d2	d3
±0.02	h6	0+0.02

MF8550-H (Hard'Xコート)

型番	WEBコード	R	d1	d2	d3	Δx	l	L	価格
MF8550-H 0.1	333551	0.10	0.5	3	0.8	0.35	2.5	50	7,320
MF8550-H 0.15	333552	0.15			0.9	0.40			7,320
MF8550-H 0.2	333553	0.20			1.0	0.45			7,320
MF8550-H 0.25	333554	0.25			1.1	0.50			7,010
MF8550-H 0.3	333555	0.30			1.2	0.55			7,010
MF8550-H 0.4	333556	0.40			1.4	0.65			7,010
MF8550-H 0.5	333557	0.50			1.6	0.75			7,010
MF8550-H 0.8	333558	0.80			2.5	1.20			7,010
MF8550-H 1.0	333559	1.00			2.9	1.40			7,010
MF8550-H 1.5	333560	1.50			5	4.6			2.25
MF8550-H 2.0	333561	2.00	5.6	2.75		8.0	8,540		
MF8550-H 2.5	333562	2.50	1.5	8	6.6	3.25	10	10,320	
MF8550-H 3.0	333563	3.00			7.6	3.75		10,320	
MF8550-H 4.0	333564	4.00	1.9	10	10.0	4.95	-	55	14,630
MF8550-H 5.0	333565	5.00		12	12.0	5.95	-	63	16,100
MF8550-H 6.0	333566	6.00	4.3	14	14.0	6.95	-	74	18,900
MF8550-H 8.0	333567	8.00		20	20.0	10.15	-	100	42,060

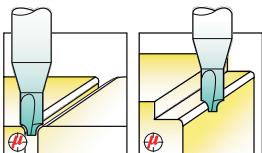

多機能工具

コンビマグ多機能エンドミル90°

COMBI-MAG

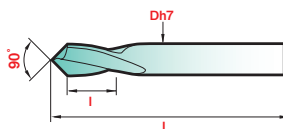

公差

D	α	l	L
h7	±1°	+1	±1

MF007 (Red'Xコート)

型番	WEBコード	D	l	L	チゼル巾	価格
MF007 3.0	MA320	3.0	6	50	0.3	1,970
MF007 4.0	MA262	4.0	8	52	0.4	2,100
MF007 5.0	MA263	5.0	10	60	0.5	2,300
MF007 6.0	MA264	6.0	12	66	0.6	2,500
MF007 8.0	MA265	8.0	14	79	0.8	2,900
MF007 10.0	MA266	10.0	16	89	1.0	3,400
MF007 12.0	MA267	12.0	18	102	1.2	4,600
MF007 14.0	MA268	14.0	21	115	1.4	6,400
MF007 16.0	MA269	16.0	24		1.6	6,700

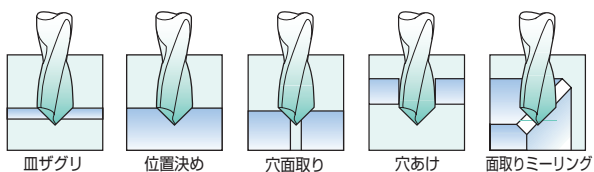

マルチV多機能エンドミル90°

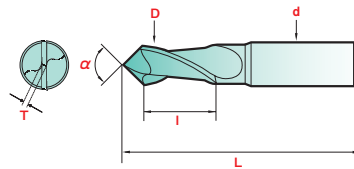
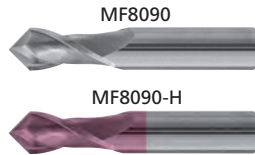

公差

D	α	L	l	d
$\phi 0.1 \sim 10 \pm 0.09$	$\pm 1'$	± 1	$+1$	$0.1 \sim 2.6 \pm 0.05$
$\phi 12 \sim 20 \pm 0.09$				$3 \sim 20 \pm 0.16$

MF8090(ノンコート)

型番	WEBコード	D	l	L	d	T	価格
MF8090 1.0	45340	1.0	2.0	39	3	0.1	4,040
MF8090 1.5	45341	1.5	3.0			0.15	4,040
MF8090 2.0	45342	2.0	4.0			0.2	4,040
MF8090 2.5	45343	2.5	5.0			0.25	4,140
MF8090 3.0	45344	3.0	6.0	50	4	0.3	5,120
MF8090 4.0	45345	4.0	8.0		5	0.4	5,310
MF8090 5.0	45346	5.0	10.0		6	0.5	6,080
MF8090 6.0	45347	6.0	12.0	60	8	0.6	6,820
MF8090 8.0	45348	8.0	16.0	70	10	0.8	10,040
MF8090 10.0	45349	10.0	18.0		12	1.0	12,540
MF8090 12.0	45350	12.0	20.0		1.2	12,540	
MF8090 16.0	45351	16.0	26.0	80	16	1.6	18,480
MF8090 20.0	45352	20.0	32.0	100	20	2.0	32,780

MF8090-H(Hard'Xコート)

型番	WEBコード	D	l	L	d	T	価格
MF8090-H 0.1	333521	0.1	0.2	39	3	0.01	9,880
MF8090-H 0.2	333522	0.2	0.4			0.02	7,320
MF8090-H 0.3	333523	0.3	0.6			0.03	6,220
MF8090-H 0.4	333524	0.4	0.8			0.04	5,610
MF8090-H 0.5	333525	0.5	1.0			0.05	4,880
MF8090-H 0.6	333526	0.6	1.2			0.06	4,880
MF8090-H 0.7	333527	0.7	1.4			0.07	4,880
MF8090-H 0.8	333528	0.8	1.6			0.08	4,880
MF8090-H 0.9	333529	0.9	1.8			0.09	4,880
MF8090-H 1.0	45353	1.0	2.0			0.1	4,480
MF8090-H 1.1	333530	1.1	2.2			0.11	4,880
MF8090-H 1.2	333531	1.2	2.4			0.12	4,880
MF8090-H 1.3	333532	1.3	2.6	50	4	0.13	4,880
MF8090-H 1.4	333533	1.4	2.8			0.14	4,880
MF8090-H 1.5	45354	1.5	3.0			0.15	4,480
MF8090-H 1.6	333534	1.6	3.2			0.16	4,880
MF8090-H 1.7	333535	1.7	3.4			0.17	4,880
MF8090-H 1.8	333536	1.8	3.6			0.18	4,880
MF8090-H 1.9	333537	1.9	3.8			0.19	4,880
MF8090-H 2.0	45355	2.0	4.0			0.2	4,480
MF8090-H 2.1	333538	2.1	4.2			0.21	5,000
MF8090-H 2.2	333539	2.2	4.4			0.22	5,000
MF8090-H 2.3	333540	2.3	4.6			0.23	5,000
MF8090-H 2.4	333541	2.4	4.8			60	5
MF8090-H 2.5	45356	2.5	5.0	0.25	4,560		
MF8090-H 3.0	45357	3.0	6.0	0.3	5,380		
MF8090-H 4.0	45358	4.0	8.0	0.4	5,580		
MF8090-H 5.0	45359	5.0	10.0	0.5	6,340		
MF8090-H 6.0	45360	6.0	12.0	0.6	7,150		
MF8090-H 8.0	45361	8.0	16.0	0.8	10,470		
MF8090-H 10.0	45362	10.0	18.0	1.0	13,200		
MF8090-H 12.0	45363	12.0	20.0	1.2	13,200		
MF8090-H 16.0	45364	16.0	26.0	1.6	19,470		
MF8090-H 20.0	45365	20.0	32.0	2.0	34,100		

多機能工具

マルチV多機能エンドミル90°(ロング)

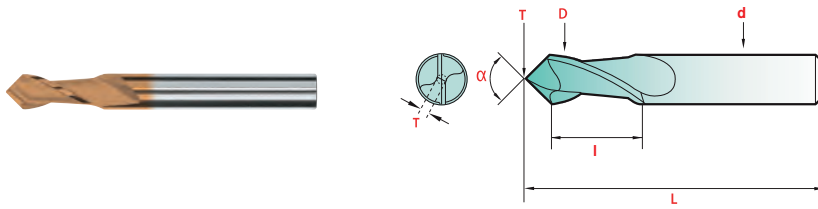

公差

D	α	d2
d9	±1'	h6

MF8089-LH (Hard'Xコート)

型番	WEBコード	α	D	L	l	d	T	価格
MF8089-LH 3.0	333542	90°	3.0	80	12	3	0.3	8,900
MF8089-LH 4.0	333543		4.0	100	16	4	0.4	10,120
MF8089-LH 5.0	333544		5.0	120	20	5	0.5	10,730
MF8089-LH 6.0	333545		6.0	140	24	6	0.6	12,070
MF8089-LH 8.0	333546		8.0		32	8	0.8	14,630
MF8089-LH 10.0	333547		10.0	170	36	10	1.0	24,400
MF8089-LH 12.0	333548		12.0		40	12	1.2	27,140
MF8089-LH 16.0	333549		16.0		52	16	1.6	48,160
MF8089-LH 20.0	333550		20.0	200	64	20	2.0	74,370

	穴あけ加工	穴面取り加工	V溝加工	皿座グリ加工	側面加工	面取り加工	深面取り加工	センタリング加工	文字彫り加工
ポイント角									
60°	×	○	×	×	○	○	○	×	○
90°	○	○	○	○	○	○	○	○	×
120°	○	○	○	○	○	○	○	○	×

- 多重機能でツールの減少、セットアップ時間の短縮、MC、NC加工には理想的な工具です。
- ネジレ角 30°で切り粉の排出が良好です。
- 超微粒子超硬合金を採用、高剛性で耐摩耗性に優れ長寿命です。

マルチV多機能エンドミル60°

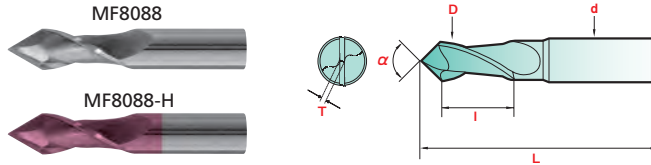

公差

D	α	L	l	d
$\phi 0.5-10+H9$	$\pm 1'$	± 1	$+1$	$0.5 \sim 2.5+H6$
$\phi 12-20+H9$				$3 \sim 20+H6$

MF8088 (ノンコート)

型番	WEBコード	D	l	L	d	T	価格
MF8088 1.0	45366	1.0	2.0	39	3	0.1	5,280
MF8088 1.5	45367	1.5	3.0			0.15	5,280
MF8088 2.0	45368	2.0	4.0			0.2	5,280
MF8088 2.5	45369	2.5	5.0			0.25	5,390
MF8088 3.0	45370	3.0	6.0	50	4	0.3	7,150
MF8088 4.0	45371	4.0	8.0		5	0.4	7,370
MF8088 5.0	45372	5.0	10.0		6	0.5	8,470
MF8088 6.0	45373	6.0	12.0	60	8	0.6	9,570
MF8088 8.0	45374	8.0	16.0		10	0.8	13,970
MF8088 10.0	45375	10.0	18.0	70	12	1.0	16,060
MF8088 12.0	45376	12.0	20.0		1.2	16,060	
MF8088 16.0	45377	16.0	26.0	80	16	1.6	23,650
MF8088 20.0	45378	20.0	32.0		105	20	2.0

MF8088-H (Hard'Xコート)

型番	WEBコード	D	l	L	d	T	価格
MF8088-H 1.0	45379	1.0	2.0	39	3	0.1	5,830
MF8088-H 1.5	45380	1.5	3.0			0.15	5,830
MF8088-H 2.0	45381	2.0	4.0			0.2	5,830
MF8088-H 2.5	45382	2.5	5.0			0.25	5,940
MF8088-H 3.0	45383	3.0	6.0	50	4	0.3	7,700
MF8088-H 4.0	45384	4.0	8.0		5	0.4	7,920
MF8088-H 5.0	45385	5.0	10.0		6	0.5	9,020
MF8088-H 6.0	45386	6.0	12.0	60	8	0.6	10,120
MF8088-H 8.0	45387	8.0	16.0		10	0.8	14,740
MF8088-H 10.0	45388	10.0	18.0	70	12	1.0	17,270
MF8088-H 12.0	45389	12.0	20.0		1.2	17,270	
MF8088-H 16.0	45390	16.0	26.0	80	16	1.6	25,410
MF8088-H 20.0	45391	20.0	32.0		105	20	2.0

	穴あけ加工	穴面取り加工	V溝加工	皿座グリ加工	側面加工	面取り加工	深面取り加工	センタリング加工	文字彫り加工
ポイント角									
60°	×	○	×	×	○	○	○	×	○
90°	○	○	○	○	○	○	○	○	×
120°	○	○	○	○	○	○	○	○	×

- 多重機能でツールの減少、セットアップ時間の短縮、MC、NC加工には理想的な工具です。
- ネジレ角 30°で切り粉の排出が良好です。
- 超微粒子超硬合金を採用、高剛性で耐摩耗性に優れ長寿命です。

多機能工具

マルチV多機能エンドミル120°

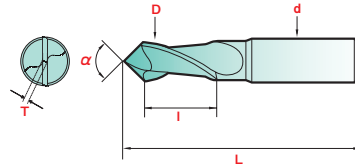
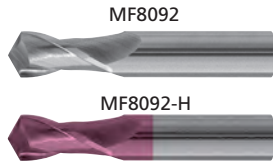

MF0892-H

公差

D	α	L	l	d
$\phi 0.5-10\pm 0.01$	$\pm 1'$	± 1	$+1$	$0.5\sim 2.5\pm 0.01$
$\phi 12-20\pm 0.02$				$3\sim 20\pm 0.03$

MF8092 (ノンコート)

型番	WEBコード	D	l	L	d	T	価格
MF8092 1.0	45392	1.0	2.0	39	3	0.1	4,730
MF8092 1.5	45393	1.5	3.0			0.15	4,730
MF8092 2.0	45394	2.0	4.0			0.2	4,730
MF8092 2.5	45395	2.5	5.0	50	5	0.25	4,840
MF8092 3.0	45396	3.0	6.0			0.3	6,270
MF8092 4.0	45397	4.0	8.0			0.4	6,490
MF8092 5.0	45398	5.0	10.0	60	6	0.5	7,590
MF8092 6.0	45399	6.0	12.0			0.6	8,580
MF8092 8.0	45400	8.0	16.0			0.8	12,650
MF8092 10.0	45401	10.0	18.0	70	10	1.0	15,840
MF8092 12.0	45402	12.0	20.0			1.2	15,840
MF8092 16.0	45403	16.0	26.0			1.6	23,430
MF8092 20.0	45404	20.0	32.0	100	20	2.0	41,690

MF8092-H (Hard'Xコート)

型番	WEBコード	D	l	L	d	T	価格
MF8092-H 1.0	45405	1.0	2.0	39	3	0.1	5,280
MF8092-H 1.5	45406	1.5	3.0			0.15	5,280
MF8092-H 2.0	45407	2.0	4.0			0.2	5,280
MF8092-H 2.5	45408	2.5	5.0	50	4	0.25	5,390
MF8092-H 3.0	45409	3.0	6.0			0.3	6,820
MF8092-H 4.0	45410	4.0	8.0			0.4	7,040
MF8092-H 5.0	45411	5.0	10.0	60	5	0.5	8,140
MF8092-H 6.0	45412	6.0	12.0			0.6	9,130
MF8092-H 8.0	45413	8.0	16.0			0.8	13,420
MF8092-H 10.0	45414	10.0	18.0	70	10	1.0	17,050
MF8092-H 12.0	45415	12.0	20.0			1.2	17,050
MF8092-H 16.0	45416	16.0	26.0			1.6	25,190
MF8092-H 20.0	45417	20.0	32.0	100	20	2.0	44,330

	穴あけ加工	穴面取り加工	V溝加工	皿座グリ加工	側面加工	面取り加工	深面取り加工	センタリング加工	文字彫り加工
ポイント角									
60°	×	○	×	×	○	○	○	×	○
90°	○	○	○	○	○	○	○	○	×
120°	○	○	○	○	○	○	○	○	×

- 多重機能でツールの減少、セットアップ時間の短縮、MC、NC加工には理想的な工具です。
- ネジレ角 30°で切り粉の排出が良好です。
- 超微粒子超硬合金を採用、高剛性で耐摩耗性に優れ長寿命です。

彫刻用エンドミル

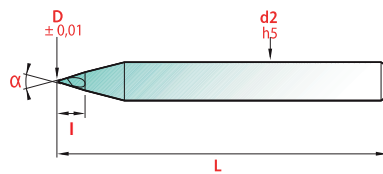

超硬 **Hard'X**

MF8540-H	MF8540	MF8560	MF8590
MF8560-H	MF8540-H	MF8560-H	MF8590-H

40° 60° 90°

MF8540

型番	WEBコード	α	D	L	l	d2	価格
MF8540 0.05	333568	40°	0.05	39	1	3	3,540
MF8540 0.1	333569		0.10				3,360
MF8540 0.15	333570		0.15				3,360
MF8540 0.2	333571		0.20				3,360

MF8540-H (Hard'Xコート)

型番	WEBコード	α	D	L	l	d2	価格
MF8540-H 0.05	333572	40°	0.05	39	1	3	4,270
MF8540-H 0.1	333573		0.10				4,090
MF8540-H 0.15	333574		0.15				4,090
MF8540-H 0.2	333575		0.20				4,090

MF8560

型番	WEBコード	α	D	L	l	d2	価格
MF8560 0.05	333576	60°	0.05	39	1	3	3,540
MF8560 0.1	333577		0.10				3,360
MF8560 0.15	333578		0.15				3,360
MF8560 0.2	333579		0.20				3,360

MF8560-H (Hard'Xコート)

型番	WEBコード	α	D	L	l	d2	価格
MF8560-H 0.05	333580	60°	0.05	39	1	3	4,270
MF8560-H 0.1	333581		0.10				4,090
MF8560-H 0.15	333582		0.15				4,090
MF8560-H 0.2	333583		0.20				4,090

MF8590

型番	WEBコード	α	D	L	l	d2	価格
MF8590 0.05	333584	90°	0.05	39	1	3	3,540
MF8590 0.1	333585		0.10				3,360
MF8590 0.15	333586		0.15				3,360
MF8590 0.2	333587		0.20				3,360

MF8590-H (Hard'Xコート)

型番	WEBコード	α	D	L	l	d2	価格
MF8590-H 0.05	333588	90°	0.05	39	1	3	4,270
MF8590-H 0.1	333589		0.10				4,090
MF8590-H 0.15	333590		0.15				4,090
MF8590-H 0.2	333591		0.20				4,090

製品別推奨切削条件

■ カウンターシンク

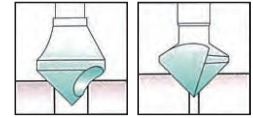
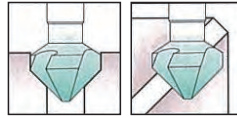

ワーク材質	サイズ	周速	MF431 MF437 MF432	MF493A MF4731 MF4737	MF8431-H	MF411 MF412	MF4811	MF421 MF422	MF4721
		送り	HSS-Co	HSS-Co +Red'X	超硬+Hard'X	HSS-Co	HSS-Co +TiN	HSS-Co	HSS-Co +Red'X
一般鋼 ≤500N/mm ²		V(m/min)	17~22	35~45	40~80	35~45			
	φ10	F (mm/min)	85	165	250	165			
	φ20		45	85	125	85			
φ30	30		55	85	55				
一般鋼 500~ 800N/mm ²		V(m/min)	10~15	20~30	30~60	20~30			
	φ10	F (mm/min)	60	110	170	110			
	φ20		30	55	85	55			
φ30	20		35	60	35				
一般鋼 800~ 1000N/mm ²		V(m/min)	8~12	16~20	20~40	15~20			
	φ10	F (mm/min)	35	55	100	55			
	φ20		25	35	60	35			
φ30	15		25	45	25				
ステンレス鋼 1000~ 1300N/mm ²		V(m/min)	6~10	12~15	20~40	12~15			
	φ10	F (mm/min)	30	45	100	45			
	φ20		15	25	60	25			
φ30	10		20	60	20				
合金鋼		V(m/min)		12~15	15~20				
	φ10	F (mm/min)		40	55				
	φ20			30	35				
φ30			20	25					
インコネル ナイモニック		V(m/min)		4~6	10~12				
	φ10	F (mm/min)		16	30				
	φ20			8	16				
φ30			6	10					
高硬度鋼 ≤HRC60		V(m/min)			10~12				
	φ10	F (mm/min)			30				
	φ20				16				
φ30				10					
鋳鉄		V(m/min)	15~25	20~40	40~80	20~40			
	φ10	F (mm/min)	70	125	250	125			
	φ20		40	75	150	75			
φ30	30		50	100	50				
アルミニウム		V(m/min)	35~45	50~60	40~100	50~60			
	φ10	F (mm/min)	200	255	350	255			
	φ20		130	180	230	180			
φ30	110		150	200	150				
真鍮		V(m/min)	20~30	30~40		30~40			
	φ10	F (mm/min)	120	150		150			
	φ20		85	110		110			
φ30	70		90		90				
銅		V(m/min)	15~25	20~30	50~80	20~30			
	φ10	F (mm/min)	95	120	300	120			
	φ20		60	80	200	80			
φ30	45		65	175	65				
軟質樹脂		V(m/min)	35~70	35~70		50~100			
	φ10	F (mm/min)	300	300		400			
	φ20		200	200		300			
φ30	150		150		250				
硬質樹脂		V(m/min)	35~70	35~70		50~100			
	φ10	F (mm/min)	400	400		450			
	φ20		300	300		350			
φ30	250		250		300				



■ センタードリル ■ NC スポットティングドリル

ワーク材質	サイズ	周速	MF110, MF15, MF14, MF13	MF118, MF18, MF10, MF019(L/XL), MF016(L/XL), MF195, MF196, MF197, MF199	MF0818, MF0811, MF0895, MF0896	MF0919(L/XL) MF0916(L/XL)	MF8100, MF8119, MF819-D, MF8195, MF8196, MF8197	MF8119-H, MF819-DH, MF8190-H, MF8195-H, MF8196-H, MF8197-H
			送り	HSS	HSS-Co	HSS-Co+TiN	HSS-Co + Red'X	超硬
一般鋼 ≤500N/mm ²		V(m/min)	30~35	35~45	45~55	45~60		
	φ2~3	f (mm/rev)	0.08~0.10	0.08~0.10	0.08~0.10	0.08~0.10		
	φ6~10		0.15~0.25	0.15~0.25	0.15~0.25	0.15~0.25		
φ16	0.3		0.3	0.3	0.3			
一般鋼 500~ 800N/mm ²		V(m/min)	20~25	30~40	40~50	40~55		
	φ2~3	f (mm/rev)	0.08~0.10	0.08~0.10	0.08~0.10	0.08~0.10		
	φ6~10		0.15~0.25	0.15~0.25	0.15~0.25	0.15~0.25		
φ16	0.3		0.3	0.3	0.3			
一般鋼 800~ 1000N/mm ²		V(m/min)	15~25	25~35	35~45	35~50	40~55	
	φ2~3	f (mm/rev)	0.05~0.07	0.05~0.07	0.05~0.07	0.05~0.07	0.07~0.09	
	φ6~10		0.14~0.20	0.14~0.20	0.14~0.20	0.14~0.20	0.15~0.22	
φ16	0.25		0.25	0.25	0.25	0.27		
ステンレス鋼 1000~ 1300N/mm ²		V(m/min)	6~10	10~15	15~20	20~25	25~30	25~40
	φ2~3	f (mm/rev)	0.04~0.06	0.04~0.06	0.04~0.06	0.04~0.06	0.06~0.08	0.06~0.08
	φ6~10		0.12~0.18	0.12~0.18	0.12~0.18	0.12~0.18	0.15~0.22	0.15~0.22
φ16	0.22		0.22	0.22	0.22	0.25	0.25	
合金鋼 <420HB		V(m/min)		8~10	12~15	15~25	25~30	25~30
	φ2~3	f (mm/rev)		0.04~0.06	0.04~0.06	0.04~0.06	0.06~0.08	0.06~0.08
	φ6~10			0.12~0.15	0.12~0.15	0.12~0.15	0.15~0.17	0.15~0.17
φ16			0.18	0.18	0.18	0.2	0.2	
インコネル ナイモニック		V(m/min)		5~6	8~10	15~20	20~30	20~30
	φ2~3	f (mm/rev)		0.03~0.04	0.03~0.04	0.03~0.04	0.05~0.06	0.05~0.06
	φ6~10			0.06~0.12	0.06~0.12	0.06~0.12	0.08~0.15	0.08~0.15
φ16			0.15	0.15	0.15	0.17	0.17	
高硬度鋼 ≤HRC60		V(m/min)					10~15	10~15
	φ2~3	f (mm/rev)					0.04~0.05	0.04~0.05
	φ6~10						0.06~0.10	0.06~0.10
φ16						0.12	0.12	
鋳鉄		V(m/min)	15~20	20~30	30~40	35~45	45~50	45~50
	φ2~3	f (mm/rev)	0.08~0.10	0.08~0.10	0.08~0.10	0.08~0.10	0.10~0.12	0.10~0.12
	φ6~10		0.15~0.20	0.15~0.20	0.15~0.20	0.15~0.20	0.17~0.25	0.17~0.25
φ16	0.25		0.25	0.25	0.25	0.27	0.27	
アルミニウム		V(m/min)	60~80	70~80	80~90	85~100	100~110	100~150
	φ2~3	f (mm/rev)	0.10~0.12	0.10~0.12	0.10~0.12	0.10~0.12	0.12~0.14	0.12~0.14
	φ6~10		0.15~0.20	0.15~0.20	0.15~0.20	0.15~0.20	0.17~0.25	0.17~0.25
φ16	0.25		0.25	0.25	0.25	0.27	0.27	
真鍮		V(m/min)	30~35	35~45	45~50	45~55	55~60	55~60
	φ2~3	f (mm/rev)	0.08~0.10	0.08~0.10	0.08~0.10	0.08~0.10	0.10~0.12	0.10~0.12
	φ6~10		0.15~0.20	0.15~0.20	0.15~0.20	0.15~0.20	0.17~0.25	0.17~0.25
φ16	0.25		0.25	0.25	0.25	0.27	0.27	
銅		V(m/min)	40~50	45~55	55~60	55~65	65~70	65~70
	φ2~3	f (mm/rev)	0.08~0.10	0.08~0.10	0.08~0.10	0.08~0.10	0.10~0.12	0.10~0.12
	φ6~10		0.15~0.20	0.15~0.20	0.15~0.20	0.15~0.20	0.17~0.25	0.17~0.25
φ16	0.25		0.25	0.25	0.25	0.27	0.27	
軟質樹脂		V(m/min)	35~40	40~50	50~55	50~60	60~65	
	φ2~3	f (mm/rev)	0.12~0.14	0.12~0.14	0.12~0.14	0.12~0.14	0.15~0.16	
	φ6~10		0.20~0.25	0.20~0.25	0.20~0.25	0.20~0.25	0.25~0.30	
φ16	0.3		0.3	0.3	0.3	0.35		
硬質樹脂		V(m/min)	50~80	60~100	70~120	80~130	150~200	
	φ2~3	f (mm/rev)	0.12~0.14	0.12~0.14	0.12~0.14	0.12~0.14	0.15~0.16	
	φ6~10		0.20~0.25	0.20~0.25	0.20~0.25	0.20~0.25	0.25~0.30	
φ16	0.3		0.3	0.3	0.3	0.35		

製品別推奨切削条件

■ マシンリーマ

ワーク材質		V (m/min)		f (mm/rev)					
		超硬	HSS	φ1	φ2	φ6	φ10	φ15	φ20
一般鋼	≤500N/mm ²	25~40	15~22	0.07	0.15	0.15	0.25	0.25	0.3
	500~800N/mm ²	20~25	12~17	0.07	0.1	0.12	0.18	0.18	0.25
	800~1000N/mm ²	12~18	7~10	0.07	0.08	0.1	0.18	0.15	0.22
	1000~1300N/mm ²	10~15	5~7	0.07	0.08	0.09	0.15	0.2	0.25
ステンレス鋼		7~12	3~5	0.07	0.07	0.1	0.12	0.15	0.2
インコネル/ナイモニック/ チタン合金		6~10	2~3	0.07	0.07	0.1	0.12	0.15	0.2
鋳鉄	<180HB	15~20	6~15	0.08	0.1	0.12	0.2	0.2	0.25
	>180HB	8~15	4~5	0.08	0.07	0.1	0.15	0.18	0.2
銅		25~30	12~20	0.08	0.12	0.18	0.2	0.25	0.3
真鍮		35~40	20~30	0.07	0.2	0.22	0.3	0.35	0.4
青銅		20~25	12~17	0.08	0.15	0.18	0.22	0.35	0.37
アルミニウム		40~60	25~35	0.08	0.15	0.18	0.25	0.3	0.35

■ 面取りカッタ

ワーク材質		周速 V=m/min		送り f (mm/tooth)				
		ノンコート	Hard'X	φ1~2	φ3~4	φ6~8	φ10~12	φ16
一般鋼	≤500N/mm ²	60~70	70~90	0.01	0.012	0.015	0.02	0.03
	500~800N/mm ²	40~60	50~80	0.01	0.012	0.015	0.02	0.03
	800~1000N/mm ²	35~40	45~60	0.01	0.012	0.013	0.017	0.025
	1000~1300N/mm ²	30~35	40~55	0.01	0.012	0.013	0.017	0.025
ステンレス鋼/チタン合金		25~30	35~50	0.007	0.01	0.01	0.015	0.02
インコネル/ナイモニック/ ワスパロイ		15~20	25~40	0.007	0.01	0.01	0.015	0.02
鋳鉄	<180HB	35~40	45~60	0.01	0.012	0.013	0.017	0.025
	>180HB	30~35	40~55	0.01	0.012	0.013	0.017	0.025
銅/青銅/真鍮		50~80	60~100	0.012	0.012	0.015	0.02	0.03
アルミニウム≤6% Si		70~100	80~120	0.012	0.012	0.015	0.02	0.03
アルミニウム> 6% Si		90~150	110~180	0.012	0.012	0.015	0.02	0.03
熱可逆性材料		100~150	130~200	0.015	0.025	0.03	0.04	0.05



多機能工具

 90°-100°-120°
センターリング

 60°-90°-100°-120°
穴面取り

 90°-100°-120°
穴あけ加工

被削材	周速 V (m/min)	送り f (mm/tooth) φ									
		0.3	0.5	1	2	3	5	8	12	16	20
一般鋼 ≤500N/mm ²	60~75	0.003	0.005	0.01	0.025	0.05	0.1	0.15	0.2	0.25	0.3
一般鋼 500~800N/mm ²	40~60	0.003	0.005	0.012	0.025	0.05	0.1	0.15	0.2	0.25	0.3
一般鋼 800~1000N/mm ²	35~40	0.003	0.005	0.01	0.023	0.045	0.07	0.12	0.18	0.22	0.28
高炭素鋼・ ステンレス・鋳鉄	30~35	0.002	0.004	0.009	0.023	0.045	0.07	0.12	0.17	0.22	0.26
チタン合金	25~30	0.002	0.004	0.01	0.02	0.04	0.06	0.11	0.16	0.22	0.25
インコネル	15~20	0.002	0.004	0.01	0.02	0.04	0.06	0.11	0.16	0.2	0.25
銅合金・青銅	50~120	0.0026	0.005	0.025	0.05	0.1	0.15	0.25	0.3	0.35	0.45
アルミニウム	80~150	0.004	0.007	0.015	0.03	0.05	0.09	0.15	0.2	0.27	0.35
樹脂	100~200	0.005	0.008	0.015	0.03	0.05	0.1	0.2	0.2	0.3	0.4

 90°-100°-120°
V溝加工

被削材	周速 V (m/min)	送り f (mm/tooth) φ									
		0.3	0.5	1	2	3	5	8	12	16	20
一般鋼 ≤500N/mm ²	60~75	0.0015	0.0025	0.0045	0.008	0.01	0.018	0.03	0.04	0.05	0.065
一般鋼 500~800N/mm ²	40~60	0.0013	0.002	0.004	0.008	0.01	0.015	0.03	0.04	0.05	0.065
一般鋼 800~1000N/mm ²	35~40	0.0013	0.002	0.004	0.008	0.01	0.015	0.03	0.04	0.05	0.065
高炭素鋼・ ステンレス・鋳鉄	30~35	0.001	0.0017	0.0035	0.006	0.008	0.012	0.025	0.032	0.04	0.055
チタン合金	25~30	0.001	0.0017	0.0035	0.006	0.008	0.012	0.025	0.032	0.04	0.055
インコネル	15~20	0.001	0.0012	0.0025	0.005	0.006	0.01	0.02	0.026	0.036	0.05
銅合金・青銅	50~120	0.0013	0.0025	0.006	0.012	0.016	0.02	0.034	0.04	0.06	0.08
アルミニウム	80~150	0.0013	0.0035	0.006	0.012	0.016	0.021	0.034	0.04	0.06	0.08
樹脂	100~200	0.0015	0.004	0.0065	0.013	0.02	0.03	0.045	0.06	0.09	0.1

 60°-90°-100°-120°
深面取り

 40°-60°
文字彫り

 90°-100°-120°
皿座グリ

 60°-90°-100°-120°
側面加工

被削材	周速 V (m/min)	送り f (mm/tooth) φ									
		0.3	0.5	1	2	3	5	8	12	16	20
一般鋼 ≤500N/mm ²	60~75	0.002	0.004	0.008	0.012	0.015	0.021	0.038	0.06	0.08	0.1
一般鋼 500~800N/mm ²	40~60	0.0015	0.0035	0.007	0.012	0.015	0.02	0.038	0.06	0.08	0.1
一般鋼 800~1000N/mm ²	35~40	0.0015	0.003	0.01	0.012	0.014	0.02	0.038	0.06	0.08	0.09
高炭素鋼・ ステンレス・鋳鉄	30~35	0.001	0.003	0.007	0.012	0.014	0.02	0.038	0.055	0.075	0.08
チタン合金	25~30	0.001	0.002	0.005	0.01	0.012	0.018	0.035	0.05	0.065	0.08
インコネル	15~20	0.001	0.002	0.005	0.01	0.012	0.018	0.035	0.05	0.065	0.08
銅合金・青銅	50~120	0.002	0.005	0.01	0.015	0.02	0.025	0.045	0.07	0.075	0.1
アルミニウム	80~150	0.002	0.0045	0.008	0.012	0.017	0.02	0.04	0.06	0.07	0.09
樹脂	100~200	0.0025	0.005	0.01	0.015	0.02	0.025	0.045	0.07	0.075	0.1



Cominix